

**1.0 12V 3C - FORTWO**

**MTR: 132.910 - GAS**

25306-JGCB	JG JTA MTR S/ CAB	25306-JGRS	JG RETIF MTR S/ CAB
25306-JGSC	JG JTA MTR C/ CAB DE FIBRA	25306-JGRV	JG RETIF MTR C/ CAB DE FIBRA
25306-JGML	JG JTA MTR C/ CAB DE CHAPA	25306-JGRM	JG RETIF MTR C/ CAB DE CHAPA
25306-JRSC	JG JTA MTR C/ CAB DE FIBRA E C/ RET	25306-JRRV	JG RETIF MTR C/ CAB DE FIBRA E RET
25306-JRML	JG JTA MTR C/ CAB DE CHAPA E C/ RET	25306-JRRM	JG RETIF MTR C/ CAB DE CHAPA E RET



25301 SC - 1,20 MM - CIL. 73 MM  
25301 MLS - 0,70 MM - CIL. 73 MM  
JUNTA CABEÇOTE

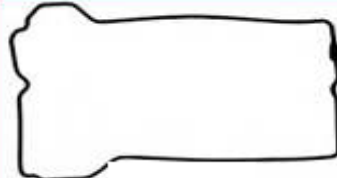

25326 BO - JUNTA TAMPA VALVULAS



25345 JGBO - JOGO VEDADORES DA VELA



25320 JGBO  
JUNTA COLETOR ADMISSÃO



25321 F  
JUNTA COLETOR ESCAPE



25306 KTBO - KIT BORRACHAS MOTOR

**XXXXX-KP**  
**KIT PARAFUSOS DO CABEÇOTE**

**25306-KTRT OU 25306-KTBO-FR**  
**KIT DE RETENORES DO MOTOR**

RET HASTE VALVULAS  
(5x11x19,8)



125008101

RET DIANT. VIRABREQUIM

RET GIRABREQUIM DIANT.

(26x40x6,5)



115018101

RET FLANGE TRASEIRA



25306 FR

**1.6 8V 4C - MB - CLASSE A 160 97/05**

**MTR: MB 166.960 / MB 166.961 - GAS**

25108-JGCB JG JTA MTR S/ CAB

25108-JGSC JG JTA MTR C/ CAB DE FIBRA

25108-JGML JG JTA MTR C/ CAB DE CHAPA

25108-JRSC JG JTA MTR C/ CAB DE FIBRA E C/ RET

25108-JRML JG JTA MTR C/ CAB DE CHAPA E C/ RET

25108-JGRS JG RETIF MTR S/ CAB

25108-JGRV JG RETIF MTR C/ CAB DE FIBRA

25108-JGRM JG RETIF MTR C/ CAB DE CHAPA

25108-JRRV JG RETIF MTR C/ CAB DE FIBRA E RET

25108-JRRM JG RETIF MTR C/ CAB DE CHAPA E RET



25101 SC - 1,4 MM - 81 MM

25101 MLS - 1,4 MM - 81 MM

JTA CABEÇOTE

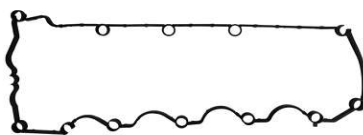

25026 BO

JTA TAMPA VÁLVULAS



25021 F

JTA COLETOR ESCAPE



25020 JGBO

JTA COLETOR ADMISSÃO



25081 BO

JTA CORPO  
BORBOLETA

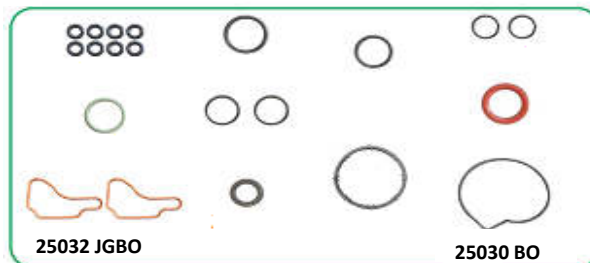

25032 JGBO

25030 BO

25006 KTBO - KIT BORRACHAS MOTOR

JG JTA RETIFICAÇÃO



261216

ARRUELA DO BUJÃO  
DE CARTER



25044 NA

JTA



25041 NA

JTA



25043 NA

JTA

25108-KP

KIT PARAFUSOS DO CABEÇOTE

10.00X1.50X182.00 (X10)

25108-KTRT OU 25108-KTRT-FR

KIT DE RETENORES DO MOTOR

RET HASTE VALVULAS

(7x9,5x8,5)



1260028

RET HASTE VALVULAS

(6x9x10)



1219203

RET VIRABREQUIM DIANT.

(40x62x7,5)



1130045

FLANGE TRASEIRA



25108 F

**1.8 16V 4C** - C160 / C180 / C200 / CLK200: 02/ - E200 03/ - SLK200 / C230: 04/ : KOMPRESSOR

MTR: MB 2713921 / 271.940 - MB 271.946 / 271.941 - MB 271.948 - GAS

25007-JGCB	JG JTA MTR S/ CAB	25007-JGRS	JG RETIF MTR S/ CAB
25007-JGSC	JG JTA MTR C/ CAB DE FIBRA	25007-JGRV	JG RETIF MTR C/ CAB DE FIBRA
25007-JGML	JG JTA MTR C/ CAB DE CHAPA	25007-JGRM	JG RETIF MTR C/ CAB DE CHAPA
25007-JRSC	JG JTA MTR C/ CAB DE FIBRA E C/ RET	25007-JRRV	JG RETIF MTR C/ CAB DE FIBRA E RET
25007-JRML	JG JTA MTR C/ CAB DE CHAPA E C/ RET	25007-JRRM	JG RETIF MTR C/ CAB DE CHAPA E RET

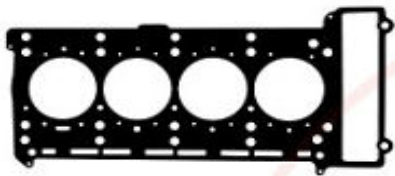

25001 SC  
25001 MLS  
JUNTA CABEÇOTE



25126 KTBO  
KIT JUNTAS TAMPA VÁLVULAS



25023 JGBO BO  
JUNTA COLETOR ADMISSÃO



25024 F  
JUNTA COLETOR ESCAPE

JG JTA RETIFICAÇÃO

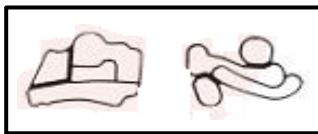

25044 KTBO  
KIT BORRACHAS RADIADOR ÓLEO



25041 JGNA  
JOGO JUNTAS EGR



25007 KTBO 01  
KIT BORRACHAS MOTOR



25007 KTBO  
KIT BORRACHAS MOTOR



25042 KTBO - KIT BORRACHAS BOMBA VÁCUO



25032 NA  
JUNTA



25033 NA  
JUNTA



25034 BO  
JUNTA



25035 BO  
JUNTA

25007-KP  
KIT PARAFUSOS DO CABEÇOTE  
10.00X1.50X165.00 (X10)

25007-KTRT OU 25007-KTRT-F  
KIT DE RETENORES DO MOTOR

RET HASTE VALVULAS



R831002  
RET GIRABREQUIM DIANT.

45 X 67 X 08



R834001

FLANGE TRASEIRA



25007 FR

**1.9 8V 4C - MB - CLASSE A 190 00/05**

**MTR: MB 166.990 / MB 166.991 - GAS**

25109-JGCB JG JTA MTR S/ CAB

25109-JGSC JG JTA MTR C/ CAB DE FIBRA

25109-JGML JG JTA MTR C/ CAB DE CHAPA

25109-JRSC JG JTA MTR C/ CAB DE FIBRA E C/ RET

25109-JRML JG JTA MTR C/ CAB DE CHAPA E C/ RET

25109-JGRS JG RETIF MTR S/ CAB

25109-JGRV JG RETIF MTR C/ CAB DE FIBRA

25109-JGRM JG RETIF MTR C/ CAB DE CHAPA

25109-JRRV JG RETIF MTR C/ CAB DE FIBRA E RET

25109-JRRM JG RETIF MTR C/ CAB DE CHAPA E RET



**25102 SC** - 1,4 MM - CIL. 85,3 MM  
**25102 MLS** - 1,4 MM - CIL.85,3 MM  
JTA CABEÇOTE

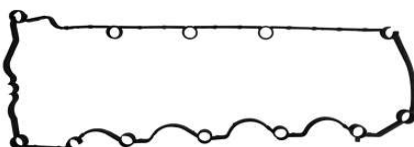

**25026 BO**  
JTA DA TAMPA DE VÁLVULAS



**25021 F**  
JTA COLETOR ESCAPE



**25020 JGBO**  
JTA COLETOR ADMISSÃO



**25081 BO**  
JTA CORPO  
BORBOLETA

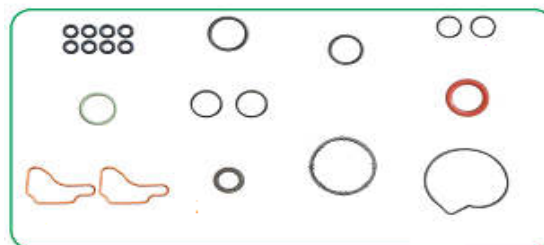

**25006 KTBO** - KIT BORRACHAS MOTOR

JG JTA RETIFICAÇÃO



**261216**  
ARRUELA DO BUJÃO  
DE CARTER



**25044 NA**  
JTA



**25041 NA**  
JTA



**25043 NA**  
JTA

**25108-KP**

**KIT PARAFUSOS DO CABEÇOTE**

**10.00X1.50X182.00 (X10)**

**25108-KTRT OU 25108-KTRT-F**

**KIT DE RETENORES DO MOTOR**

**RET HASTE VALVULAS**

(7x9,5x8,5)



**1260028**

**RET HASTE VALVULAS**

(6x9x10)



**1219203**

**RET VIRABREQUIM DIANT.**

(40x62x7,5)



**1130045**

**FLANGE TRASEIRA**



**25108 F**

**2.0 16V 4C** - C200 CGI 94/00 - E200 95/01 - SLK200 - CLK200 - SLK C200 KOMPRESSOR

MTR: E 20 M 111.942 / 2.0 L 16V M 111.945: GAS

25006-JGCB JG JTA MTR S/ CAB

25006-JGSC JG JTA MTR C/ CAB DE FIBRA

25006-JRSC JG JTA MTR C/ CAB DE FIBRA E C/ RET

25006-JGRS JG RETIF MTR S/ CAB

25006-JGRV JG RETIF MTR C/ CAB DE FIBRA

25006-JRRV JG RETIF MTR C/ CAB DE FIBRA E RET

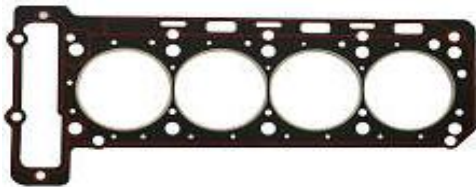

25401 SC  
JUNTA CABEÇOTE

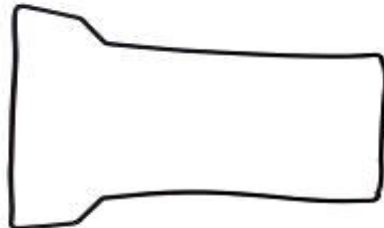

25027 BO  
JUNTA TAMPA VALVULAS



25018 F  
JUNTA COLETOR ESCAPE



25030 MLS  
JUNTA BOMBA  
D'AGUA



25033 BO  
VEDADOR

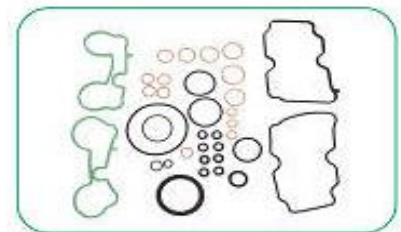

25006 KTBO - KIT BORRACHAS MOTOR

JG JTA RETIFICAÇÃO

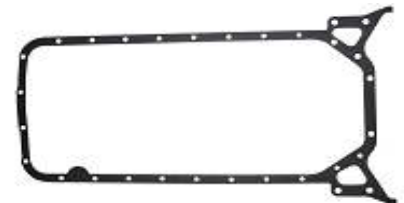

25016 NA  
JUNTA CARTER

XXXXX-KP  
KIT PARAFUSOS DO CABEÇOTE

25006-KTRT  
KIT DE RETENORES DO MOTOR

RET HASTE VALVULAS

(6x9x10)



1219203

RET DIANT. VIRABREQUIM

(32x47x10)



1111942

RET GIRABREQUIM TRAS - RET GIRABREQUIM DIANT.



**2.2 16V 4C - MB:**SPRINTER CDI 99/ 311 / 312 / 313 / 412 / 413

**2.2 16V 4C- CHRYSLER:** PT CRUISER EDJ 02/

**MTR: MB 611.980 / MB 611.981 / MB 611.987 - DIESEL**

49110-JGCB	JG JTA MTR S/ CAB	49110-JGRS	JG RETIF MTR S/ CAB
49110-JGSC	JG JTA MTR C/ CAB DE FIBRA	49110-JGRV	JG RETIF MTR C/ CAB DE FIBRA
49110-JGML	JG JTA MTR C/ CAB DE CHAPA	49110-JGRM	JG RETIF MTR C/ CAB DE CHAPA
49110-JRSC	JG JTA MTR C/ CAB DE FIBRA E C/ RET	49110-JRRV	JG RETIF MTR C/ CAB DE FIBRA E RET
49110-JRML	JG JTA MTR C/ CAB DE CHAPA E C/ RET	49110-JRRM	JG RETIF MTR C/ CAB DE CHAPA E RET



49101 SC - 1,6 MM  
49101 MLS - 1,5 MM

**OPCIONAL**

49101 SC-3M - 1,70 MM - CIL. 89 MM

JTA CABEÇOTE



49119 NA  
JTA COLETOR ADMISSÃO



49126 BO - JTA TAMPA VÁLVULAS



49145 JGBO - JG DE JTAS DAS VELAS DA TV

49126 KTBO - KIT JUNTAS TAMPA VALVULAS



49120 JG BO  
JTA COLETOR ADMISSÃO



49158 NA  
JTA VÁLVULA EGR

49120 KTBN - JTA COLETOR ADMISSÃO



49121 F - JTA COLETOR ESCAPE

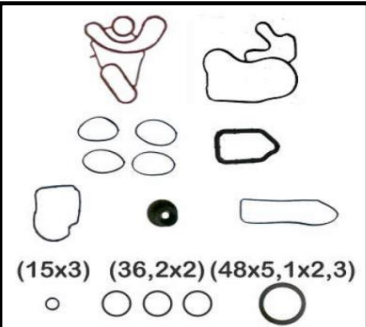

(15x3) (36,2x2) (48x5,1x2,3)

49110 KTBO -KIT BORRACHAS MOTOR

JG JTA RETIFICAÇÃO



49110 KTAR  
KIT DE ARRUELAS DO MOTOR



49134 NA  
JTA



49130 NA  
JTA DA BBA D'ADUA



49116 NA  
JTA CARTER

49110-KP  
KIT PARAFUSOS DO CABEÇOTE  
12.00X1.75X101.00 (X10)

49110-KTRT E 49110-KTRT-F  
KIT DE RETENORES DO MOTOR

RET HASTE VALVULAS  
(7x9,5x8,5)



1260028

RET VIRABREQUIM DIANT.  
(45x67x8)



1160028

FLANGE TRASEIRA



49110 FR

**2.2 16V 4C - MB - SPRINTER CDI : 311 / 313 / 314 / 415 / 515 / 516: 11/22**

**MTR: OM 651 LA DSL TURBO INJ DIR / OM 651 LA: BI TURBO EURO 5 - DIESEL**

49112-JGCB	JG JTA MTR S/ CAB	49112-JGRS	JG RETIF MTR S/ CAB
49112-JGSC	JG JTA MTR C/ CAB DE FIBRA	49112-JGRV	JG RETIF MTR C/ CAB DE FIBRA
49112-JGML	JG JTA MTR C/ CAB DE CHAPA	49112-JGRM	JG RETIF MTR C/ CAB DE CHAPA
49112-JRSC	JG JTA MTR C/ CAB DE FIBRA E C/ RET	49112-JRRV	JG RETIF MTR C/ CAB DE FIBRA E RET
49112-JRML	JG JTA MTR C/ CAB DE CHAPA E C/ RET	49112-JRRM	JG RETIF MTR C/ CAB DE CHAPA E RET



49102 SC - 1,8 MM - CIL. 84 MM  
49102 MLS - 1,5 MM - CIL. 84 MM  
JTA CABEÇOTE

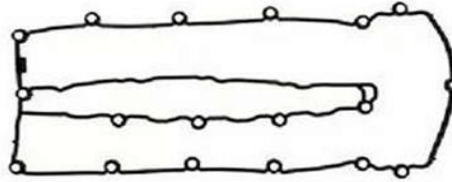

49125 BO - JTA TAMPA VÁLVULAS



49123 F - JTA COLETOR ESCAPE

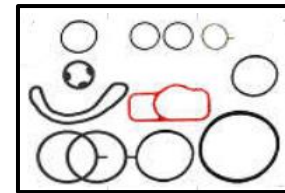

49112 KTBO - KIT BORRACHAS MOTOR



49118 BO  
JTA COLETOR ADMISSÃO

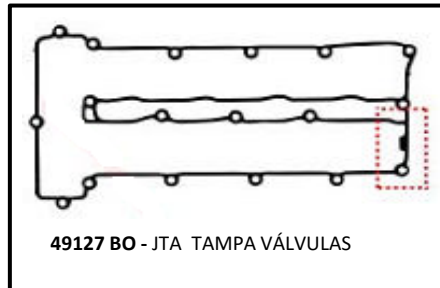

49127 BO - JTA TAMPA VÁLVULAS



49112 KTBO 01  
KIT BORRACHAS MOTOR



49149 DI - DIAFRAGMA TAMPA VÁLVULAS

JG JTA RETIFICAÇÃO

**OPCIONAL**



49133 MLS  
JTA BBA D'AGUA



49144 KTBO



49141 BO  
JTA TROCADOR CALOR

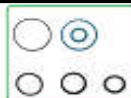

49112 KTBO 02  
KIT BORRACHAS MOTOR

49155 KTBO  
KIT JTA RAD ÓLEO TROCADOR CALOR



49128 NA  
JTA BBA ÓLEO



49142 NA  
JTA



49140 NA  
JTA



49132 NA  
JTA



49144 NA - JTA BBA ÓLEO



49148 NA  
JTA BBA ÓLEO



49141 NA  
JTA



49131 MLS  
JTA BBA D'AGUA



49117 NA  
JTA CARTER

**XXXXX-KP**  
**KIT PARAFUSOS DO CABEÇOTE**

**49112-KTRT**  
**KIT DE RETENORES DO MOTOR**

**RET HASTE VALVULAS**

(6x9x10)



**1219203**

**RET VIRABREQUIM DIANT.**

(60x75x7)



**1150175**

**RET VIRABREQUIM TRAS.**

(114x96x9)



**1160230**

**2.4 8V 4C** - MB 180 93/96

**MTR: MB616.940 / MB616.961 - DIESEL**

48006-JGCB JG JTA MTR S/ CAB

48006-JGSC JG JTA MTR C/ CAB DE FIBRA

48006-JRSC JG JTA MTR C/ CAB DE FIBRA E C/ RET

48006-JGRS JG RETIF MTR S/ CAB

48006-JGRV JG RETIF MTR C/ CAB DE FIBRA

48006-JRRV JG RETIF MTR C/ CAB DE FIBRA E RET

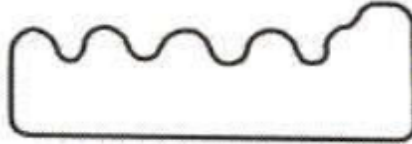

48026 BO - JTA TAMPA VÁLVULAS

48001 SC - 1,8 MM - CIL. 92 MM  
JTA CABEÇOTE



48021 PAK  
JTA COLETOR ESCAPE



48630 F  
JTA ESCAPE



48032 NA  
JTA  
THERMOSTATO

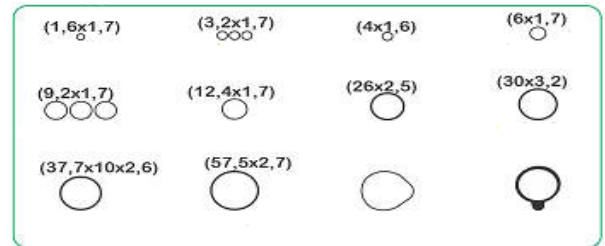

48006 BO - KIT BORRACHAS MOTOR

JG JTA RETIFICAÇÃO



48038 NA  
JTA BBA  
VÁCUO  
(2X)

48036 NA  
JTA

48039 NA  
JTA BBA  
HIDRÁ(2X)

48043 NA  
JTA TPA  
ÓLEO

48031NA  
JTA

48047 NA  
JTA

48035 NA  
JTA  
TENSOR  
HIDRÁUL.

48038 NA  
JTA INTER  
CAMB.

48037 NA  
JTA

48034 NA  
JTA

48040 NA  
JTA



48033 NA  
JTA



48042 NA  
JTA



48044  
NA  
JTA



48074 NA  
JTA



48045 NA  
JTA



48041 NA  
JTA TER-  
MOSTATO



48079 A  
GAXETA  
MANCAL



48046 NA  
JTA



48015 NA  
JTA SUB  
CARTER



48016 NA  
JTA CARTER

**XXXXX-KP**  
**KIT PARAFUSOS DO CABEÇOTE**

**48006-KTRT**  
**KIT DE RETENORES DO MOTOR**  
**RET HASTE VALVULAS**

(10x14x12,2)



**1250035**

**RET VIRABREQUIM DIANT.**

(45x74,5x12)



**1150035**



**2.5 8V 4C - GM** - S10 95/00 - BLAZER: 96/01

**2.5 8V 4C - FORD** - F1000 96/98 - RANGER 97/01

**2.5 8V 4C - MB** - SPRINTER 96/01

**2.5 8V 4C - LAND ROVER** - DISCOVERY / DEFENDER: 98/05

**MTR: MAXION HS 310D / 312 D - TDI - DIESEL**

70106-JGCB	JG JTA MTR S/ CAB	70106-JGRS	JG RETIF MTR S/ CAB
70106-JGSC	JG JTA MTR C/ CAB DE FIBRA 3M	70106-JGRV	JG RETIF MTR C/ CAB DE FIBRA 3M
70106-JGML	JG JTA MTR C/ CAB DE CHAPA 3M	70106-JGRM	JG RETIF MTR C/ CAB DE CHAPA 3M
70106-JRSC	JG JTA MTR C/ CAB DE FIBRA 3M E C/ RET	70106-JRRV	JG RETIF MTR C/ CAB DE FIBRA 3M E RET
70106-JRML	JG JTA MTR C/ CAB DE CHAPA 3M E C/ RET	70106-JRRM	JG RETIF MTR C/ CAB DE CHAPA 3M E RET



**OPCIONAL**

- 70101 SC-1M - 1,37 MM - CIL. 92 MM
- 70101 SC-2M - 1,45 MM - CIL. 92 MM
- 70101 SC-3M - 1,60 MM - CIL. 92 MM
- 70101 MLS-1M - 1,37 MM - CIL. 92 MM
- 70101 MLS-2M - 1,48 MM - CIL. 92 MM
- 70101 MLS-3M - 1,60 MM - CIL. 92 MM
- 70101 MLS-4M - 2,00 MM - CIL. 92 MM

JTA CABEÇOTE



70145 NA - JTA BBA D'AGUA



70144 NA - JTA TERMOSTATO



70127 BO -- JTA TAMPA VALVULAS



70244 BO - VEDADOR TAMPA VÁLVULAS

70127 KTBO - KIT JTA TAMPA VÁLVULAS



70120 F - JTA COL ETOR ESCAPE

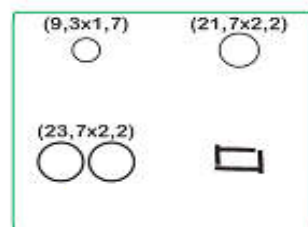

70106 KTBO - KIT VEDADORES MOTOR



70142 NA  
JTA BBA  
D'AGUA



70149 NA  
JTA FILTRO  
ÓLEO

JG JTA RETIFICAÇÃO



70146 NA  
JTA TUBO  
INSPEÇÃO



70151 NA  
JTA BBA INJETORA



70148 NA  
JTA BBA VÁCUO



70134 NA  
JTA



70135 NA  
JTA PAVIO VEDAÇÃO



10296 NA  
JTA BBA COMBÚSTIVEL



70152 NA  
JTA RETENTOR  
TRASEIRO



70141 NA  
JTA TAMPA DISTRIBUIÇÃO



70140 NA  
JTA DISTRIBUIÇÃO INTERNA



70115 CBLT - JTA CARTER

**70106-KP**  
**KIT PARAFUSOS DO CABEÇOTE**

- 10.00X1.50X117.00 (X4)
- 12.00X1.50X100.00 (X4)
- 12.00X1.50X140.00 (X10)

**70106 KTRT** OU **70106 KTRT-F (com flange)**  
**KIT DE RETENORES DO MOTOR**

**RET HASTE VALVULAS**



(8x12x11)  
**1222396**  
FLANGE



**70106 FR**

**RET COMANDO**

(46,7x62,3x9)



**1150009**

**RET GIRABREQUIM DIANT**



(57x71x9)  
**1150109**

**2.6/2.8/3.2 24V V6** - C280 93/97 - C240 00/05 - C320 99/05 - E280 93/03 - E320 97/05 - CLK 03/05 - SLK 99/04

S280 93/98 - AMG KOMPRESSOR

MTR: **MB112 912 / MB112913 / MB112914 / MB112916**

25207-JGCB	JG JTA MTR S/ CAB	25207-JGRS	JG RETIF MTR S/ CAB
25207-JGSC	JG JTA MTR C/ CAB DE FIBRA	25207-JGRV	JG RETIF MTR C/ CAB DE FIBRA
25207-JGML	JG JTA MTR C/ CAB DE CHAPA	25207-JGRM	JG RETIF MTR C/ CAB DE CHAPA
25207-JRSC	JG JTA MTR C/ CAB DE FIBRA E C/ RET	25207-JRRV	JG RETIF MTR C/ CAB DE FIBRA E RET
25207-JRML	JG JTA MTR C/ CAB DE CHAPA E C/ RET	25207-JRRM	JG RETIF MTR C/ CAB DE CHAPA E RET

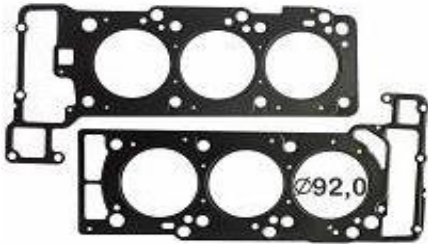

**25202 MLS** - 0,65 MM - CIL. 92 MM  
JUNTA CABEÇOTE - PAR

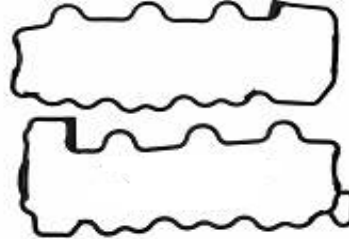

**25226 KTBO**  
KIT JUNTA TAMPA VALVULAS



**25221 MP**  
KIT JUNTA COLETOR ESCAPE



**25222 F**  
JUNTA ESCAPE



**25221 BI**  
KIT JUNTA COLETOR ADMISSÃO

JG JTA RETIFICAÇÃO

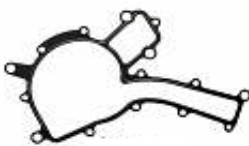

**25230 MLS**  
JUNTA BOMBA D'AGUA

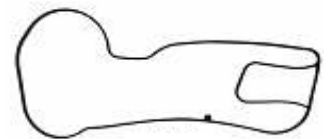

**25229 BO**  
VEDADOR

**XXXXX-KP**  
KIT PARAFUSOS DO CABEÇOTE

**25207-KTRT**  
KIT DE RETENORES DO MOTOR

RET HASTE VALVULAS



RET GIRABREQUIM DIANT.



RET GIRABREQUIM TRAS.

(93x114x11.5)



**2.7 20V 5C - MB** - SPRINTER: E270 ML / ML270 / C270 / G270 / CLK / ACELLO 715C: 03/09

**2.7 20V 5C - JEEP** - GRAND CHEROCKEE 01/04

MTR: DE LA-OM 612.963 DSL-TD 2.7-DDAB-ENF DSL-**MB612:962/961/965: TURBO DIESEL INJ DIRETA**

49306-JGCB	JG JTA MTR S/ CAB	49306-JGRS	JG RETIF MTR S/ CAB
49306-JGSC	JG JTA MTR C/ CAB DE FIBRA	49306-JGRV	JG RETIF MTR C/ CAB DE FIBRA
49306-JGML	JG JTA MTR C/ CAB DE CHAPA	49306-JGRM	JG RETIF MTR C/ CAB DE CHAPA
49306-JRSC	JG JTA MTR C/ CAB DE FIBRA E C/ RET	49306-JRRV	JG RETIF MTR C/ CAB DE FIBRA E RET
49306-JRML	JG JTA MTR C/ CAB DE CHAPA E C/ RET	49306-JRRM	JG RETIF MTR C/ CAB DE CHAPA E RET



49103 SC - 1,4 MM - CIL. 89 MM  
49103 MLS - 1,5 MM - CIL. 89 MM

**OPCIONAL**

49103 SC-2M - 1,6 MM - CIL. 89 MM

JTA CABEÇOTE



49220 NA  
JTA ADMISSÃO



49326 BO - JTA DA TAMPA DE VÁLVULAS



49345 JGBO - JG DE JTAS DAS VELAS DA TV

49326 KTBO - KIT DE JTAS DA TV



49124 JGBO  
JTA COL. ADMISSÃO



49158 NA  
JTA VÁLVULA EGR

49124 KTBN - KIT JTA COL. ADMISSÃO/EGR



49221 F -JTA DO COLETOR DE ESCAPE

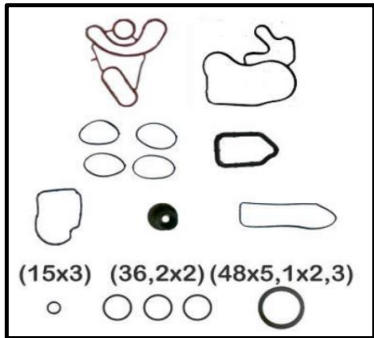

(15x3) (36,2x2) (48x5,1x2,3)

49306 KTBO - KIT BORRACHAS MOTOR

JG JTA RETIFICAÇÃO

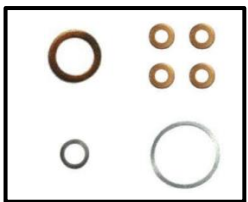

49110 KTAR  
KIT DE ARRUELAS DO MOTOR



49329 BO  
JTA



49232 NA  
JTA DA BBA D'ADUA



49134 NA  
JTA



49130 NA  
JTA DA BBA D'ADUA



49115 NA  
JTA CARTER

**XXXXX-KP**  
**KIT PARAFUSOS DO CABEÇOTE**

**49306-KTRT E 49306-KTRT-F**  
**KIT DE RETENORES DO MOTOR**

RET HASTE VALVULAS  
(7x9,5x8,5)



**1260028**

RET VIRABREQUIM DIANT.

(45x67x8)



**1160028**

FLANGE TRASEIRA



**49110 FR**

**3.8 8V 4C - MB** - L608D 70/88 - L708E 87/90 - LO603 75/79 - LO608 73/87 - LO708 87/89

**3.8 8V 4C - TOYOTA** - BANDEIRANTE 68/01 - LAND CRUISER TB 25/43: 60/68

**MTR: OM 314 / OM 314 DSL INJ DIR - DIESEL**

48308-JGCB	JG JTA MTR S/ CAB	48308-JGRS	JG RETIF MTR S/ CAB
48308-JGSC	JG JTA MTR C/ CAB DE FIBRA	48308-JGRV	JG RETIF MTR C/ CAB DE FIBRA
48308-JGML	JG JTA MTR C/ CAB DE CHAPA	48308-JGRM	JG RETIF MTR C/ CAB DE CHAPA
48308-JRSC	JG JTA MTR C/ CAB DE FIBRA E C/ RET	48308-JRRV	JG RETIF MTR C/ CAB DE FIBRA E RET
48308-JRML	JG JTA MTR C/ CAB DE CHAPA E C/ RET	48308-JRRM	JG RETIF MTR C/ CAB DE CHAPA E RET



**48301 SC - 1,80 MM**  
JUNTA CABEÇOTE

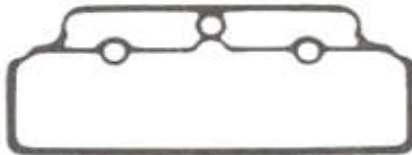

**48426 PAK - JUNTA TAMPA VALVULAS**



**48221 CV**  
JUNTA COLETOR ESCAPE



**48139 PAK**  
JUNTA ESCAPE



**48337 NA**  
JUNTA BOMBA D'AGUA



**48446 NA**  
JUNTA TERMOSTATO



**48127 CB - JUNTA TAMPA VALVULAS LATERAL**



**48338 NA**  
JUNTA TUBO SUCCÃO



**48342 NA**  
JUNTA TUBO SUCCÃO



**48333 NA**  
JUNTA



**48341 NA**  
JUNTA CANO D'AGUA



**48334 NA**  
JUNTA



**48344 NA**  
JUNTA COMPRESSOR AR



**48834 NA**  
JUNTA BBA ALIMENTADORA



**48342 NA**  
JUNTA



**48335 NA**  
JUNTA FILTRO ÓLEO



**48328 CB**  
JUNTA DISTRIBUIÇÃO



**48136 NA**  
JUNTA BOMBA D'AGUA



**48129 NA**  
JUNTA DISTRIBUIÇÃO INTERNA



**48309 KTBO**  
KIT ARRUELAS MOTOR



**48326 NA**  
JUNTA TAMPA DISTRIBUIÇÃO



**48330 NA**  
JUNTA RADIADOR ÓLEO



**48850 A**  
GAXETA MANCAL TRASEIRO



**48316 CB**  
JUNTA CARTER

**48309-KP**

**KIT PARAFUSOS DO CABEÇOTE**  
12.00X1.75X111.00/12.90 (X17)

**RETENTOR POLIA**

(65x90x15)



**1161810**

**3.8 16V 4C AGRALE** - 10000: LX/S-6500/75008700: LX/S-LINHA MA E MT: 4/21

**3.8 16V 4C MERCEDES** - LO 815: 13/21

**3.8 16V 4C VOLARE** - TURISMO 4X4-ACCESS: 15/21-ATTACK 16/21-FLY 9/10: 16/17-WFLY:14/21

**3.8 16V 4C VW** - 5150 Á 9160 OD PLUS: 12/21-DELIVERY: 5-150/10-160/13-180/13-160/ATÉ 10-160: 12/21

**MTR: ISF 3.8 DSL TURBO INJ DIR**

60007-JGCB	JG JTA MTR S/ CAB	60007-JGRS	JG RETIF MTR S/ CAB
60007-JGSC	JG JTA MTR C/ CAB DE FIBRA	60007-JGRV	JG RETIF MTR C/ CAB DE FIBRA
60007-JGML	JG JTA MTR C/ CAB DE CHAPA	60007-JGRM	JG RETIF MTR C/ CAB DE CHAPA
60007-JRSC	JG JTA MTR C/ CAB DE FIBRA E C/ RET	60007-JRRV	JG RETIF MTR C/ CAB DE FIBRA E RET
60007-JRML	JG JTA MTR C/ CAB DE CHAPA E C/ RET	60007-JRRM	JG RETIF MTR C/ CAB DE CHAPA E RET

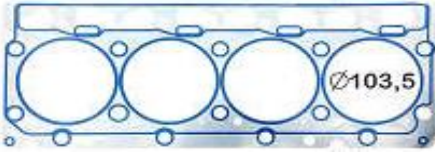

**60405 MLS** 1,15 MM - CIL. 103,5 MM  
JUNTA DO CABEÇOTE



**60027 BO**  
JUNTA DA TAMPA DE VALVULAS



**60024 F**  
JUNTA DO COLETOR DE ESCAPE



**60019 NA**  
JUNTA DO COLETOR DE ESCAPE

Medidas	Qt.
2012	3
7560	3
7487	1
7206	1
7956	1
7209	1
7241	1
7969	1
7098	1

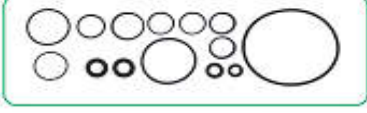

**60007 KTBO** - KIT DE BORRACHAS DO MOTOR  
JG JTA RETIFICAÇÃO



**60007 KTAR 01**  
KIT ARRUELAS DO MOTOR



**60035 PAK**  
JUNTA BOMBA HIDRÁULICA



**60034 BO**  
JUNTA



**60043 MLS**  
JUNTA BOMBA DO ÓLEO



**60044 MLS**  
JUNTA DO RESFRIADOR DO ÓLEO



**60086 MLS** - KIT JUNTAS DA TURBINA



**60017 BO** - JUNTA CATER

**XXXXX-KP**  
KIT PARAFUSOS DO CABEÇOTE

**60007-KTRT**  
KIT DE RETENORES DO MOTOR

RET HASTE VALVULAS

(9,2x7x15,2)



**129001008**

(24x40x7)



**119011020**

(70x100x12,5)



**119011008**

(130x150x12/13)



**119021020**

**4.0 8V 4C** - 1214C / 710 / 712 / 712E / 912 / 914 / L1114 / L709 / LB/LO814 / LO610 / LO712 / LO812: 88/12

**MTR: OM 364 LA / OM 364 LA DSL TURBO INJ DIR - DIESEL**

48309-JGCB	JG JTA MTR S/ CAB	47406-JGRS	JG RETIF MTR S/ CAB
47406-JGSC	JG JTA MTR C/ CAB DE FIBRA	47406-JGRV	JG RETIF MTR C/ CAB DE FIBRA
47406-JGML	JG JTA MTR C/ CAB DE CHAPA	47406-JGRM	JG RETIF MTR C/ CAB DE CHAPA
47406-JRSC	JG JTA MTR C/ CAB DE FIBRA E C/ RET	47406-JRRV	JG RETIF MTR C/ CAB DE FIBRA E RET
47406-JRML	JG JTA MTR C/ CAB DE CHAPA E C/ RET	47406-JRRM	JG RETIF MTR C/ CAB DE CHAPA E RET



**48305 SC**  
JUNTA CABEÇOTE



**48426 PAK**  
JUNTA TAMPA VALVULAS



**48221 CV**  
JUNTA COLETOR ESCAPE



**48139 PAK**  
JUNTA ESCAPE



**48337 NA**  
JUNTA BOMBA D'AGUA



**48446 NA**  
JUNTA TERMOSTATO



**48325 BO**  
JUNTA TAMPA VALVULAS LATERAL



**48222**  
JUNTA COLETOR ADMISSÃO



**48333 NA**  
JUNTA



**48341 NA**  
JUNTA CANO D'AGUA



**48334 NA**  
JUNTA



**48875 NA**  
JUNTA COMPRESSOR AR



**48834 NA**  
JUNTA BBA ALIMENTADORA



**48342 NA**  
JUNTA



**48335 NA**  
JUNTA FILTRO ÓLEO



**48328 CB**  
JUNTA DISTRIBUIÇÃO



**48850 A**  
GAXETA MANCAL TRASEIRO



**48136 NA**  
JUNTA BOMBA D'AGUA



**48129 NA**  
JUNTA DISTRIBUIÇÃO INTERNA

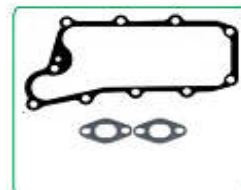

**48368 NA**  
KIT JUNTA RADIADOR ÓLEO/ TROCADOR CALOR



**48326 NA**  
JUNTA TAMPA DISTRIBUIÇÃO

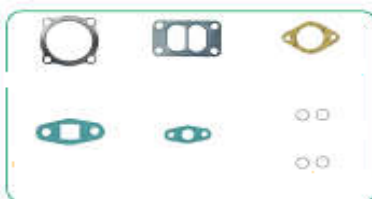

**48196 CV**  
JOGO DE JUNTAS TURBINA



**48309 KTBO**  
KIT ARRUELAS MOTOR



**48330 NA**  
JUNTA RADIADOR ÓLEO

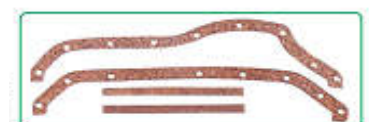

**48316 CB**  
JUNTA CARTER

**48309-KP**  
**KIT PARAFUSOS DO CABEÇOTE**  
**12.00X1.75X111.00/12.90 (X17)**

**RETENTOR POLIA**

(65x90x15)



**1161810**

**4.3 12V 4C** - 1215C 99/05 - 1318 03/04 - 1618M 98/06 - 1718M 01/05 - 712C 98/05 - 914C 98/06 - 915E 04/11

ACCELO 915 03/11 - ATEGO 04/11 - L1218EL - L1418EL - 01/05 - LO914 99/04 - LO915 04/11 - OF1218 08/12

OF1417 99/03 - OF1418 04/11 - OH1417 03/04 - OH 1418 03/07 - OH 1518 07/11

**MTR: OM 904 LA / OM 904 LA DSL TURBO INJ DIR - (TV PLASTICA) - DIESEL**

49109-JGCB	JG JTA MTR S/ CAB	49109-JGRS	JG RETIF MTR S/ CAB
49109-JGSC	JG JTA MTR C/ CAB DE FIBRA	49109-JGRV	JG RETIF MTR C/ CAB DE FIBRA
49109-JGML	JG JTA MTR C/ CAB DE CHAPA	49109-JGRM	JG RETIF MTR C/ CAB DE CHAPA
49109-JRSC	JG JTA MTR C/ CAB DE FIBRA E C/ RET	49109-JRRV	JG RETIF MTR C/ CAB DE FIBRA E RET
49109-JRML	JG JTA MTR C/ CAB DE CHAPA E C/ RET	49109-JRRM	JG RETIF MTR C/ CAB DE CHAPA E RET



**49001 SC** - 1,20 MM - CIL. 103,5 MM  
**49001 MLS** - 1,00 MM - CIL. 103,5 MM  
 JUNTA CABEÇOTE



**49026 BO**  
 JUNTA TAMPA VALVULAS



**49019 JGBO**  
 JOGO JUNTA COLETOR  
 ADMISSÃO



**47223 F**  
 JUNTA COLETOR  
 ESCAPE - 1 PÇ



**49447 NA**  
 JUNTA TERMOSTATO



**49109 KTAR**  
 KIT ARRUELAS MOTOR

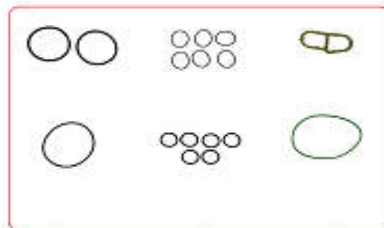

**49109 KTBO**  
 KIT BORRACHAS MOTOR

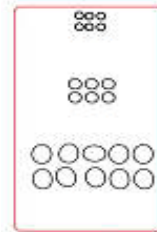

**49109 KTBO 01**  
 KIT BORRACHAS MOTOR



**49023 PAK**  
 JUNTA COLETOR  
 ADMISSÃO - 1 PÇ

**JG JTA RETIFICAÇÃO**



**49074 NA**  
 JUNTA BOMBA  
 INJETORA



**49034 NA**  
 JUNTA BOMBA  
 D'AGUA



**49044 KTBO**  
 KIT JUNTAS RADIADOR ÓLEO/  
 TROCADOR CALOR



**49016 NA**  
 JUNTA CARTER

**XXXXX-KP**  
**KIT PARAFUSOS DO CABEÇOTE**

**49109-KTRT**  
**KIT DE RETENTORES DO MOTOR**

**RET HASTE VALVULAS**

(8x12x11)



**1260031**

**RET GIRABREQUIM DIANT.**

(78x104x11)



**1160131**

**RET GIRABREQUIM TRAS.**

(115x140x13)



**1160244**

**4.8 12V 4C** - ATEGO / ACCELO: 815 / 1016 - MBB1721: 12/22 - ATRON: 1719/36 13/16 - 1319/51 12/16 - 1719/48 13/16  
MTR: OM 924 LA BLUETEC 5 OM 924 LA / OM 924 LA BLUETEC 5-OM 924 LA DSL TURBO INJ DIR - DIESEL

49105-JGCB	JG JTA MTR S/ CAB	49105-JGRS	JG RETIF MTR S/ CAB
49105-JGSC	JG JTA MTR C/ CAB DE FIBRA	49105-JGRV	JG RETIF MTR C/ CAB DE FIBRA
49105-JGML	JG JTA MTR C/ CAB DE CHAPA	49105-JGRM	JG RETIF MTR C/ CAB DE CHAPA
49105-JRSC	JG JTA MTR C/ CAB DE FIBRA E C/ RET	49105-JRRV	JG RETIF MTR C/ CAB DE FIBRA E RET
49105-JRML	JG JTA MTR C/ CAB DE CHAPA E C/ RET	49105-JRRM	JG RETIF MTR C/ CAB DE CHAPA E RET



**49002 MLS - 1,15 MM - CIL. 106,5 MM**  
JUNTA CABEÇOTE



**49026 BO**  
JUNTA TAMPA VALVULAS

**OPCIONAL**

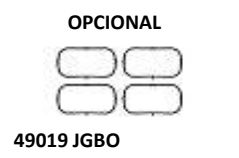

**49019 JGBO**  
JOGO JUNTA COLETOR ADMISSÃO



**47223 F**  
JUNTA COLETOR ESCAPE - 1 PÇ



**49447 NA**  
JUNTA TERMOSTATO

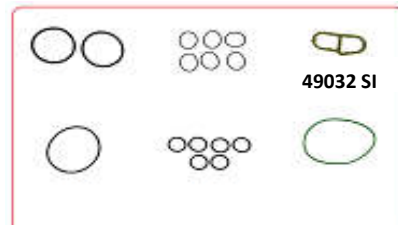

**49032 SI**

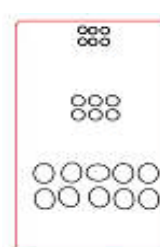

**49109 KTBO 01**  
KIT BORRACHAS MOTOR



**49023 PAK**  
JUNTA COLETOR ADMISSÃO - 1 PÇ

**JG JTA RETIFICAÇÃO**



**49074 NA**  
JUNTA BOMBA INJETORA



**49034 NA**  
JUNTA BOMBA D'AGUA





**49040 NA**    **49327 BO**    **49036 BO**



**49016 NA**  
JUNTA CARTER

**49044 KTBO**  
KIT JUNTAS RADIADOR ÓLEO/ TROCADOR CALOR

<p><b>XXXXX-KP</b> KIT PARAFUSOS DO CABEÇOTE</p>	<p><b>49109-KTRT</b> KIT DE RETENORES DO MOTOR</p> <p><b>RET HASTE VALVULAS</b> (8x12x11)  <b>1260031</b></p> <p><b>RET GIRABREQUIM DIANT.</b> (78x104x11)  <b>1160131</b></p> <p><b>RET GIRABREQUIM TRAS.</b> (115x140x13)  <b>1160244</b></p>
--	---



**5.7 12V 6C** - L1113 / L1114 / L1115 / L1118 / L1213 / L1313 / L1314: 67/98

**MTR: OM 352 / OM 352 DSL ASP INJ DIR: DIESEL**

48809-JGCB	JG JTA MTR S/ CAB	48809-JGRS	JG RETIF MTR S/ CAB
48809-JGSC	JG JTA MTR C/ CAB DE FIBRA	48809-JGRV	JG RETIF MTR C/ CAB DE FIBRA
48809-JGML	JG JTA MTR C/ CAB DE CHAPA	48809-JGRM	JG RETIF MTR C/ CAB DE CHAPA
48809-JRSC	JG JTA MTR C/ CAB DE FIBRA E C/ RET	48809-JRRV	JG RETIF MTR C/ CAB DE FIBRA E RET
48809-JRML	JG JTA MTR C/ CAB DE CHAPA E C/ RET	48809-JRRM	JG RETIF MTR C/ CAB DE CHAPA E RET



**48803 SC** - CIL. 100 MM  
JUNTA CABEÇOTE



**48832 PAK**- JUNTA TAMPA VALVULAS



**48221 CV**  
JUNTA COLETOR ESCAPE



**48227 BO**  
JUNTA TAMPA VALVULAS



**48222 PAK**  
JUNTA COLETOR ADMISSÃO



**48435 NA**  
JUNTA



**48849 NA**  
JUNTA CANO D'AGUA



**OR1-MMB 60 N**  
ANEL CARÇAÇA  
BBA D'AGUA



**48337 NA**  
JUNTA BBA  
D'AGUA



**48224 NA**  
JUNTA

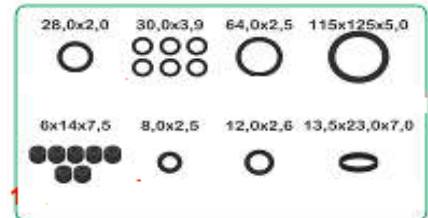

**48809 KTBO** - KIT BORRACHAS MOTOR



**48646 NA**  
JUNTA FILTRO



**48834 NA**  
JUNTA BBA ALIM.



**48 328 CB**  
JUNTA  
DISTRIBUIÇÃO



**48344 NA**  
JUNTA  
COMPRESSOR



**48850 A**  
GAXETA  
MANCAL



**48136 NA**  
JUNTA BOMBA  
INJETORA



**48430 AGF**  
JUNTA BOMBA  
D'AGUA



**48446 NA**  
JUNTA  
TERMOSTATO



**48129 NA**  
JUNTA TPA.  
DISTRIBUIÇÃO  
INTERNA



**48875 NA**  
JUNTA  
COMPRESSOR



**48835 NA**  
JUNTA  
FILTRO



**48326 NA**  
JUNTA TPA.  
DISTRIBUIÇÃO

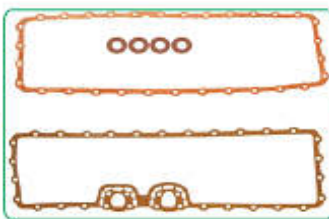

**48444 NA**  
JUNTA RADIADOR ÓLEO



**48889 NA**  
JOGO JUNTAS REFRIGERAÇÃO

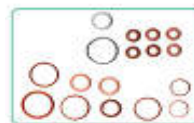

**48610 KTAR**  
KIT ARRUELAS  
MOTOR

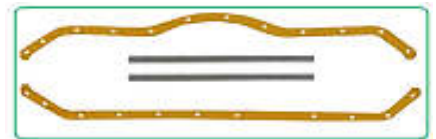

**48816 CB**  
JUNTA CARTER

**48809-KP**  
**KIT PARAFUSOS DO CABEÇOTE**  
**12.00X1.75X111.00/12.90 (X25)**

**RETENTOR POLIA**

(65x90x15)























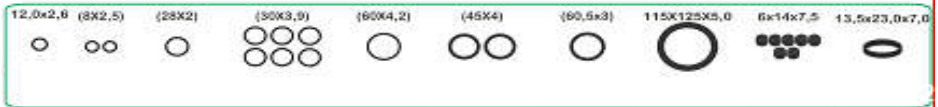



**1161810**

**6.0 12V 4C** - 1214K / 1218E / 1420 / 1714K / 1718 / 1718A / 1718K / 1718M96 / 1720 / 1720A / 1720K / 1723 / 2418 /

917 / L1214 / L1218 / L1319 / L1414 / L1418: 84/05

MTR: OM 366 / OM 366 A DSL TURBO INJ DIR: DIESEL

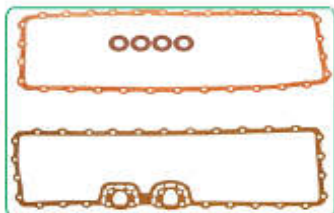
48610-JGCB	JG JTA MTR S/ CAB	48610-JGRS	JG RETIF MTR S/ CAB
48610-JGSC	JG JTA MTR C/ CAB DE FIBRA	48610-JGRV	JG RETIF MTR C/ CAB DE FIBRA
48610-JGML	JG JTA MTR C/ CAB DE CHAPA	48610-JGRM	JG RETIF MTR C/ CAB DE CHAPA
48610-JRSC	JG JTA MTR C/ CAB DE FIBRA E C/ RET	48610-JRRV	JG RETIF MTR C/ CAB DE FIBRA E RET
48610-JRML	JG JTA MTR C/ CAB DE CHAPA E C/ RET	48610-JRRM	JG RETIF MTR C/ CAB DE CHAPA E RET

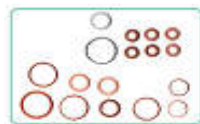
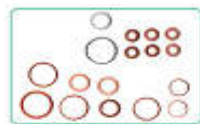
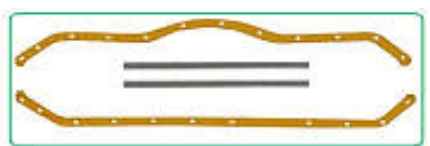
 <p><b>48805 SC 100 - CIL. 100 MM</b> JUNTA CABEÇOTE</p>		 <p><b>48432 PAK - JUNTA TAMPA VALVULAS</b></p>		 <p><b>48221 CV</b> JUNTA COLETOR ESCAPE</p>		
 <p><b>48622 PAK</b> JUNTA</p>	 <p><b>48337 NA</b> JUNTA BBA D'AGUA</p>	 <p><b>48446 NA</b> JUNTA TERMOSTATO</p>	 <p><b>48227 BO - JUNTA TAMPA VALVULAS</b></p>		 <p><b>48222 PAK</b> JUNTA COLETOR ADMISSÃO</p>	
 <p><b>48435 NA</b> JUNTA</p>	 <p><b>48341 NA</b> JUNTA CANO D'AGUA</p>	 <p><b>48610 KTBO - KIT BORRACHAS MOTOR</b></p>				
 <p><b>48646 NA</b> JUNTA FILTRO</p>	 <p><b>48834 NA</b> JUNTA BBA ALIM.</p>	 <p><b>48328 CB</b> JUNTA DISTRIBUIÇÃO</p>	 <p><b>48675 NA</b> JUNTA COMPRESSOR</p>	 <p><b>48875 NA</b> JUNTA COMPRESSOR</p>	 <p><b>48224 NA</b> JUNTA</p>	 <p><b>OR1-MMB 60 N</b> ANEL CARÇAÇA BBA D'AGUA</p>
 <p><b>48850 A</b> GAXETA MANCAL</p>	 <p><b>48136 NA</b> JUNTA BOMBA INJETORA</p>	 <p><b>48430 AGF</b> JUNTA BOMBA D'AGUA</p>	 <p><b>48129 NA</b> JUNTA TPA. DISTRIBUIÇÃO INTERNA</p>	 <p><b>48326 NA</b> JUNTA TPA. DISTRIBUIÇÃO</p>		
 <p><b>48444 NA</b> JUNTA RADIADOR ÓLEO</p>		 <p><b>48345 NA</b>   <b>48347 NA</b> <b>48346 NA</b>   <b>48341 NA</b></p>	 <p><b>48889 NA</b> JOGO JUNTAS REFRIGERAÇÃO</p>	 <p><b>48610 KTAR</b> KIT ARRUELAS MOTOR</p>	 <p><b>48816 CB</b> JUNTA CARTER</p>	

**48809-KP**  
**KIT PARAFUSOS DO CABEÇOTE**  
12.00X1.75X111.00/12.90 (X25)

**RETENTOR POLIA**

(65x90x15)  
  
**1161810**

**6.4 18V 6C** - 1728 03/06 - 2423k99/06 - 2428 01/06 - 2726 08/11 - 2726k 08/11 - ATEGO: 2425 / 1725: 04/11

AXOR 2826 06/11 - L1620 06/11 - 0500 01/12

MTR: OM 906 LA / OM 906 LA DSL TURBO INJ DIR (TV PLÁSTICA) - DIESEL

49108-JGCB	JG JTA MTR S/ CAB	49108-JGRS	JG RETIF MTR S/ CAB
49108-JGSC	JG JTA MTR C/ CAB DE FIBRA	49108-JGRV	JG RETIF MTR C/ CAB DE FIBRA
49108-JGML	JG JTA MTR C/ CAB DE CHAPA	49108-JGRM	JG RETIF MTR C/ CAB DE CHAPA
49108-JRSC	JG JTA MTR C/ CAB DE FIBRA E C/ RET	49108-JRRV	JG RETIF MTR C/ CAB DE FIBRA E RET
49108-JRML	JG JTA MTR C/ CAB DE CHAPA E C/ RET	49108-JRRM	JG RETIF MTR C/ CAB DE CHAPA E RET



**49003 MLS** - 1,15 MM - CIL. 103,5 MM  
JUNTA CABEÇOTE

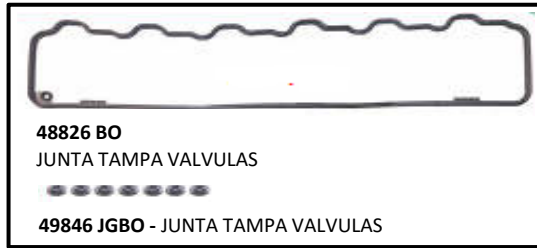

**48826 BO**  
JUNTA TAMPA VALVULAS

**49846 JGBO** - JUNTA TAMPA VALVULAS

**48826 KTBO** - KIT JUNTA TAMPA VALVULAS



**47223 F**  
JUNTA COLETOR  
ESCAPE - 1 PÇ



**49447 NA**  
JUNTA  
TERMOSTATO

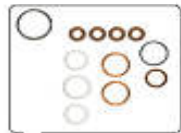

**49109 KTAR**  
KIT ARRUELAS  
MOTOR

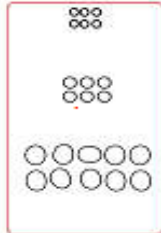

**49109 KTBO 01**  
KIT BORRACHAS  
MOTOR

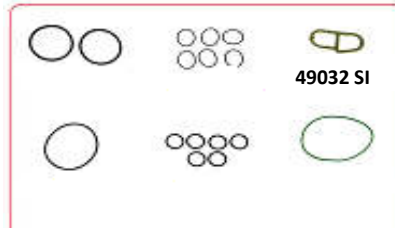

**49109 KTBO**  
KIT BORRACHAS MOTOR

**49032 SI**

OPCIONAL

**49018 JGBO**  
JOGO JUNTA COLETOR  
ADMISSÃO



**49023 PAK**  
JUNTA COLETOR  
ADMISSÃO - 1 PÇ

JG JTA RETIFICAÇÃO



**49041 NA**  
**49327 BO**  
**49036 BO**  
**49043 KTBO**  
KIT JUNTAS RADIADOR ÓLEO/



**49034 NA**  
JUNTA BOMBA  
D'ÁGUA



**49074 NA**  
JUNTA BOMBA  
INJETORA



**49017 NA**  
JUNTA CARTER

**XXXXX-KP**  
KIT PARAFUSOS DO CABEÇOTE

**49108-KTRT**  
KIT DE RETENORES DO MOTOR

RET HASTE VALVULAS

(8x12x11)



**1260031**

RET GIRABREQUIM DIANT.

(78x104x11)



**1160131**

RET GIRABREQUIM TRAS.

(115x140x13)



**1160244**

**7.2 18V 6C** - 1729/48 12/19 - 2730/48 16/19 - 3030 AUT 16/21 - 3030/48 16/21 - 3030/54 16/19 - 1726/36 11/22  
 1726/42 12/19 - 1726/54 11/19 - 2430/54 13/19 - 1729/36 12/22 - 2430 AUT 13/19 - 1730/36 16/22 - 2426/36 12/22  
 2426/48 12/19 - 2426/54 12/19 - 2730/36 16/21 - 3026/54 16/19 - 1726/48 11/19 - 2428 07/11 - 1730/36 16/21  
 2429/36/48/54 12/15 - 2430/36 13/19 - 2430/48 13/193026/48 16/21 - ECONFORT  
**MTR: OM 906 LA / OM 906 LA DSL TURBO INJ DIR (TV PLÁSTICA) - DIESEL**

49107-JGCB	JG JTA MTR S/ CAB	49107-JGRS	JG RETIF MTR S/ CAB
49107-JGSC	JG JTA MTR C/ CAB DE FIBRA	49107-JGRV	JG RETIF MTR C/ CAB DE FIBRA
49107-JGML	JG JTA MTR C/ CAB DE CHAPA	49107-JGRM	JG RETIF MTR C/ CAB DE CHAPA
49107-JRSC	JG JTA MTR C/ CAB DE FIBRA E C/ RET	49107-JRRV	JG RETIF MTR C/ CAB DE FIBRA E RET
49107-JRML	JG JTA MTR C/ CAB DE CHAPA E C/ RET	49107-JRRM	JG RETIF MTR C/ CAB DE CHAPA E RET



**49004 MLS** - 1,15 MM - CIL. 103,5 MM  
JUNTA CABEÇOTE



**48826 BO** - JUNTA TAMPA VALVULAS  
**49846 JGBO** - JUNTA TAMPA VALVULAS



**47223 F**  
JUNTA COLETOR ESCAPE - 1 PÇ

**48826 KTBO** - KIT JUNTA TAMPA VALVULAS



**49447 NA**  
JUNTA TERMOSTATO

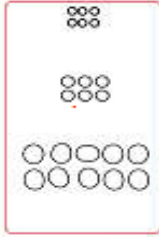

**49109 KTBO 01**  
KIT BORRACHAS MOTOR

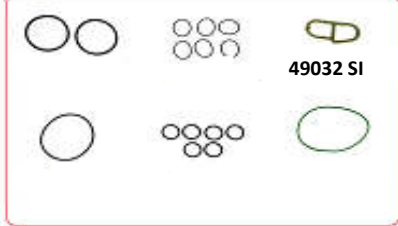

**49109 KTBO**  
KIT BORRACHAS MOTOR

**OPCIONAL**

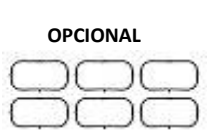

**49018 JGBO**  
JOGO JUNTA COLETOR ADMISSÃO



**49023 PAK**  
JUNTA COLETOR ADMISSÃO - 1 PÇ

**JG JTA RETIFICAÇÃO**



**49041 NA**    **49327 BO**    **49036 BO**

**49043 KTBO**  
KIT JUNTAS RADIADOR ÓLEO/



**49034 NA**  
JUNTA BOMBA D'ÁGUA



**49074 NA**  
JUNTA BOMBA INJETORA



**49017 NA**  
JUNTA CARTER

**XXXXX-KP**  
**KIT PARAFUSOS DO CABEÇOTE**

**49108-KTRT**  
**KIT DE RETENORES DO MOTOR**

**RET HASTE VALVULAS**  
(8x12x11)



**1260031**

**RET GIRABREQUIM DIANT.**  
(78x104x11)



**1160131**

**RET GIRABREQUIM TRAS.**  
(115x140x13)



**1160244**

**12.0 24V 6C** - 1938S 00/05 - 1944S 01/05 - 2638 97/05 - LK2638 98/05 - LS1938 98/05 - LS2638 98/05 - O400 92/02

O500 01/05

**MTR: OM 457 ELETRÔNICO (CABEÇOTE SEM CANALETA)**

48408-JGCB	JG JTA MTR S/ CAB	48408-JGRS	JG RETIF MTR S/ CAB
48408-JGSC	JG JTA MTR C/ CAB DE FIBRA	48408-JGRV	JG RETIF MTR C/ CAB DE FIBRA
48408-JGML	JG JTA MTR C/ CAB DE CHAPA	48408-JGRM	JG RETIF MTR C/ CAB DE CHAPA
48408-JRSC	JG JTA MTR C/ CAB DE FIBRA E C/ RET	48408-JRRV	JG RETIF MTR C/ CAB DE FIBRA E RET
48408-JRML	JG JTA MTR C/ CAB DE CHAPA E C/ RET	48408-JRRM	JG RETIF MTR C/ CAB DE CHAPA E RET

**48801 BI - CIL. 143 MM**  
JUNTA CABEÇOTE

**48526 BO**  
JUNTA TAMPA VALVULAS

**48526 NA**  
JUNTA TAMPA VALVULAS

**48223 F**  
JUNTA COLETOR ESCAPE

**48775 NA**  
JUNTA

**48441 NA**  
JUNTA

**48431 NA**  
JUNTA

**48425 NA**  
JUNTA

**48622 PAK**  
JUNTA ESCAPE

**48474 NA**  
JUNTA BOMBA INJETORA

**48422 F**

**48438 NA**      **48465NA**

**48442 KTNA**

**48408 KTAR - KIT ARRUELAS MOTOR**

**48408 KTBO - KIT BORRACHAS MOTOR**  
(2,5x15) (3,5x57) (3,5x82,5)(3,0x79,85)

**48433 NA**  
JUNTA BOMBA

**48428 OR**  
JUNTA DIANTEIRA

**48429 OR**  
JUNTA TAMPA DISTRIBUIÇÃO

**48417 AM**  
JUNTA CARTER

**XXXXX-KP**  
**KIT PARAFUSOS DO CABEÇOTE**

**48409-KTRT**  
**KIT DE RETENORES DO MOTOR**

**RET HASTE VALVULAS**  
(9x12x7)  
**1260044**

**RET GIRABREQUIM DIANT.**  
(100x130x11)  
**1160144**

**RET DIANT. VIRABREQUIM**

**RET GIRABREQUIM TRAS.**  
(115x140x13)  
**1160244**

**12.0 24V 6C** - MBB 2535 / 2540 / 2543 / 2544 / 2638 / 2640 / 2644

**MTR: OM 457 AXOR ELETRONICO ( CABEÇOTE COM CANALETA) - DIESEL**

48409-JGCB	JG JTA MTR S/ CAB	48409-JGRS	JG RETIF MTR S/ CAB
48409-JGSC	JG JTA MTR C/ CAB DE FIBRA	48409-JGRV	JG RETIF MTR C/ CAB DE FIBRA
48409-JGML	JG JTA MTR C/ CAB DE CHAPA	48409-JGRM	JG RETIF MTR C/ CAB DE CHAPA
48409-JRSC	JG JTA MTR C/ CAB DE FIBRA E C/ RET	48409-JRRV	JG RETIF MTR C/ CAB DE FIBRA E RET
48409-JRML	JG JTA MTR C/ CAB DE CHAPA E C/ RET	48409-JRRM	JG RETIF MTR C/ CAB DE CHAPA E RET



**48804 BI** - CIL. 143 MM  
JUNTA CABEÇOTE



**48526 BO**  
JUNTA TAMPA VALVULAS

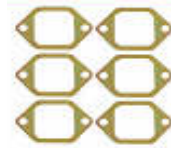

**48223 F**  
JUNTA COLETOR ESCAPE



**48526 NA**  
JUNTA TAMPA VALVULAS



**48775 NA**  
JUNTA



**48441 NA**  
JUNTA



**48431 NA**  
JUNTA



**48425 NA**  
JUNTA



**48622 PAK**  
JUNTA ESCAPE



**48474 NA**  
JUNTA BOMBA  
INJETORA



**48422 F**

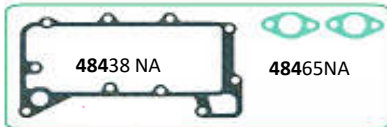

**48442 KTNA**



**48408 KTAR** - KIT ARRUELAS  
MOTOR

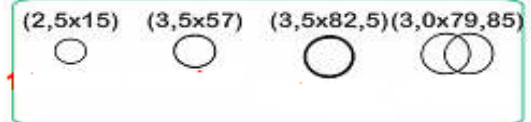

**48408 KTBO** - KIT BORRACHAS MOTOR



**48433 NA**  
JUNTA BOMBA



**48428 OR**  
JUNTA DIANTEIRA



**48429 OR**  
JUNTA TAMPA DISTRIBUIÇÃO

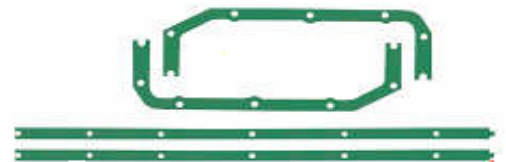

**48417 AM**  
JUNTA CARTER

**XXXXX-KP**  
KIT PARAFUSOS DO CABEÇOTE

**48409-KTRT**  
KIT DE RETENORES DO MOTOR

RET HASTE VALVULAS  
(9x12x7)



**1260044**

RET DIANT. VIRABREQUIN

RET GIRABREQUIM DIANT.

(100x130x11)



**1160144**



RET GIRABREQUIM TRAS.



(115x140x13)



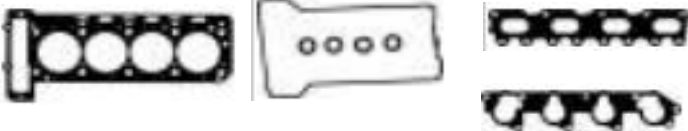

**1160244**

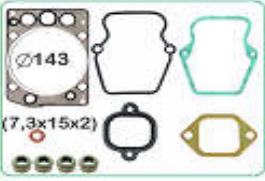
## DIVERSAS DE JOGOS DE JUNTAS DO MOTOR







 <p>25106 JRRV</p>	 <p>25906 JRSC</p>
<p>JOGO DE JUNTAS SUPERIOR E200/20/C220 2.0 16V 92/93 - 2.2 16V C200 KOMP/T/CLK 97/00</p>	<p>JOGO DE JUNTAS DO MOTOR 420SE/SEC/SEL/SL 4.2 16V 85/91 - MB116965/964</p>

 <p>48408 JRBI-01</p>	 <p>48409 JRBI-01</p>		
<p>JOGO JUNTAS CABEÇOTE 457 6C ELETRÔNICO /07 "SEM CANALETA" -P/ 1 CILINDRO</p>	<p>JOGO JUNTAS CABEÇOTE 457 6C ELETRÔNICO /07 "COM CANALETA" -P/ 1 CILINDRO</p>		

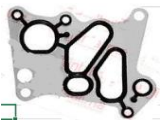
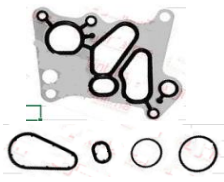





## DIVERSAS DE JUNTAS DE CABEÇOTE







 <p>25104 SC</p>	 <p>25201 SC</p>	
<p>JUNTA CABEÇOTE MERCEDES/REXTON :2.3 16V- MB111.970/975/G23D(M161.951)</p>	<p>JUNTA DO CABEÇOTE DA C280/E/CE300 2.8/3.0/3.3/3.6 24V 6C 89/96 - MB104980</p>	







## DIVERSAS DE JUNTAS DE MOTOR











 <p>25143 AL</p>	 <p>25144 KTBO</p>	 <p>48610-KTRH</p>	 <p>49129 BO</p>
<p>JUNTA RADIADOR ÓLEO C180/C200E200/SLK200</p>	<p>KIT JUNTAS RADIADOR ÓLEO E TROCADOR CALOR C180/C200E200/SLK200</p>	<p>KIT RETENTORES HASTE VÁLVULAS OM 366/366A 8 PÇS</p>	<p>JUNTA TAMPA DISTRIBUIÇÃO SPRINTER CDI 311/415/515 12/</p>
 <p>49142 BO</p>	 <p>49168 BO</p>	 <p>49234 KTMLS</p>	 <p>49249 DI</p>
<p>JUNTA RADIADOR ÓLEO SPRINTER 2.2 16V :311/312/412/413: CDI 99/</p>	<p>SELO RETORNO DO ÓLEO SPRINTER 2.2 16V 99/ CDI ELETRÔNICA</p>	<p>KIT JUNTAS VÁLVULA EGR SPRINTER CDI 311/415/515 12/-BI TURBO EURO 5-OM 651</p>	<p>SPRINTER CDI 311/415/ 515 12/-BI TURBO EURO 5 OM 651 LA - 50 MM</p>







## DIVERSAS DE JUNTAS DE TURBINA









							
48373 CV	48383 CV	59266 NA	59376 NA	70391 AI	AAA 014		
48186 CV      Jogo de juntas para turbina - Mercedes Benz 708 / D-20 / F-1000							
N/Número	Original	Descrição	QT	N/Número	Original	Descrição	QT
48373 CV	3440987080	Junta da base (c/ divisão)	01	59376 NA	1671152	Junta do cano retorno	01
48383 CV	TAF145453	Junta da base (s/ divisão)	01	70391 AI	3688A004	Junta do caracol	01
59266 NA	1671153	Junta da lubrificação	01	AAA 014		Arr. alumínio - 14 x 20 x 1,5 mm	02

							
48172 FS	48173 CV	48376 NA	59266 NA 1/16	59376 NA 1/16	AAA 026/C		
48194 CV      Jogo de juntas para turbina - Mercedes Benz 814 / 912							
N/Número	Original	Descrição	QT	N/Número	Original	Descrição	QT
48172 FS		Junta do caracol	01	59266 NA 1/16"	139471	Junta da lubrificação	02
48173 CV		Junta da base	01	59376 NA 1/16"	1671152	Junta do cano retorno	01
48376 NA		Junta do cano de retorno	01	AAA 026/C		Arr. alumínio 26x36x1,0 mm	02

							
48173 CV	48376 NA	59265 NA	59266 NA	59376 NA	71373 CV	AAA 026/C	
48196 CV      Jogo de Juntas para turbina - Mercedes Benz 709 / 712 / OM 364							
N/Número	Original	Descrição	QT	N/Número	Original	Descrição	QT
48173 CV		Junta da base	01	59376 NA	1671152	Junta do cano retorno	01
48376 NA		Junta do cano de lubrificação	01	71373 CV		Junta	01
59265 NA	139472	Junta do cano de lubrificação	01	AAA 026/C		Arr. alumínio 26 x 36 x 1,0 mm	02
59266 NA	1671153	Junta da lubrificação	01				



							
48338 NA	48372 CV	48373 CV	59266 NA	59376 NA			
							
71373 CV	AAA 010	AAA 014/A	AAA 016/A	AAA 026/C			
48197 CV      Jogo de Juntas para turbina TK 037 - Mercedes Benz L608D (caracol grande e pequena)							
N/Número	Original	Descrição	QT	N/Número	Original	Descrição	QT
48338 NA	3140160280	Junta da base (Lacón/Garret)	01	71373 CV		Junta	01
48372 CV	3520980880	Junta do caracol	01	AAA 010		Arr. alumínio	02
48373 CV	3440987080	Junta da base	01	AAA 014/A		Arr. alumínio 14 x 22 x 1,5 mm	04
59266 NA	1671153	Junta da lubrificação	01	AAA 016/A		Arr. alumínio 16 x 22 x 1,5 mm	02
59376 NA	1671152	Junta do cano retorno	01	AAA 026/C		Arr. alumínio 26 x 36 x 1,0 mm	02





							
48173 CV	48174 FA	48222 S	48420 FA	59376 NA	AAA 026/C		
48199 PAK      Jogo de juntas para turbina - Mercedes Benz 709 - Turbos Biaggio							
N/Número	Original	Descrição	QT	N/Número	Original	Descrição	QT
48173 CV		Junta da base	01	48420 FA	3644921080	Junta da saída escape	01
48174 FA		Junta	01	59376 NA	1671152	Junta do cano retorno	01
48222 S	3661410780	Junta da tubagem	02	AAA 026/C		Arr. alumínio 26 x 36 x 1,0 mm	02





							
48273 CV	48274 CV	48276 NA	AAA 012	48273 CV	48372 CV	59266 NA	59376 NA
48296 CV      Jogo de Juntas para turbina K-16 - MBB OM-904				48297 CV      Jogo de Juntas para turbina K-24 - MBB OM-904			
N/Número	Original	Descrição	QT	N/Número	Original	Descrição	QT
48273 CV		Junta da base do coletor	01	48273 CV		Junta da base	01
48274 CV		Junta da saída	01	48372 CV		Junta do caracol	01
48276 NA		Junta da lubrificação	01	59266 NA		Junta da lubrificação	01
AAA 012		Arr. alumínio - 12 x 16 x 1,0 mm	02	59376 NA		Junta do cano de retorno	01















## DIVERSAS DE JUNTAS DE TURBINA









							
48372 CV		59174 CV		59376 NA 1/16"			
48298 CV Jogo de juntas para turbina – Mercedes 906 / 926							
N/Número	Original	Descrição	QT	N/Número	Original	Descrição	QT
48372 CV	3520980880	Junta do caracol	01	59376 NA 1/16"	1671152	Junta do cano de retorno	01
59174 CV	9060987080	Junta da base	01				

									
48441 NA		48465 NA 1/16"		48775 NA		SCVO 011 CV		SCVO 112 CV	
48496 CV Jogo de juntas para turbina – Mercedes Benz OM-449 5 cilindros									
N/Número	Original	Descrição	QT	N/Número	Original	Descrição	QT		
48441 NA	6171870180	Junta cano retorno	01	SCVO 011 CV		Junta do caracol	01		
48465 NA	917003040003	Flange do aquecimento	01	SCVO 112 CV		Junta da base	01		
48775 NA	3521870080	Junta da saída de óleo	01						









									
48441 NA		48465 NA 1/16"		48775 NA		59263 CV		59777 CV	
48497 CV Jogo de juntas para turbina – Mercedes Benz OM-447 6 cilindros									
N/Número	Original	Descrição	QT	N/Número	Original	Descrição	QT		
48441 NA	6171870180	Junta cano retorno	01	59263 CV	222499	Junta do caracol	01		
48465 NA	917003040003	Flange do aquecimento	01	59777 CV	139616	Junta da base	01		
48775 NA		Junta	01						









																	
48372 CV		48373 CV		48375 NA		48376 NA		59266 NA		59268 NA		AAA 014/A		AAA 016/A		AAA 026/C	
48498 CV Jogo de Juntas para turbina - Mercedes Benz OF-1620																	
N/Número	Original	Descrição	QT	N/Número	Original	Descrição	QT										
48372 CV	3520980880	Junta do caracol	01	59268 NA		Junta do cano	01										
48373 CV	3440987080	Junta da base	02	AAA 014/A		Arr. alumínio 14 x 22 x 1,5 mm	02										
48375 NA		Junta cano retorno	01	AAA 016/A		Arr. alumínio 16 x 22 x 1,5 mm	02										
48376 NA		Junta cano lubrificação	01	AAA 026/C		Arr. alumínio 26 x 36 x 1,0 mm	02										
59266 NA	1671153	Junta da lubrificação	01														

							
48572 CV		59263 CV		59376 NA 1/16"			
48586 CV Jogo de juntas para turbina – Mercedes 457 Axor							
N/Número	Original	Descrição	QT	N/Número	Original	Descrição	QT
48572 CV		Junta da base	01	59376 NA 1/16"	1671152	Junta do cano de retorno	01
59263 CV	222499	Junta do caracol	01				









									
48372 CV		48375 NA		48376 NA		48383 CV			
									
59266 NA		59268 NA		AAA 014/A		AAA 016/A		AAA 026/C	
48890 CV Jogo de Juntas para turbina - Mercedes Benz OM 352 (base s/ divisão)									
N/Número	Original	Descrição	QT	N/Número	Original	Descrição	QT		
48372 CV	3520980880	Junta do caracol	01	59268 NA		Junta do cano	01		
48375 NA		Junta cano retorno	01	AAA 014/A		Arr. alumínio 14 x 22 x 1,5 mm	02		
48376 NA		Junta cano lubrificação	01	AAA 016/A		Arr. alumínio 16 x 22 x 1,5 mm	02		
48383 CV	TAF145453	Junta da base	01	AAA 026/C		Arr. alumínio 26 x 36 x 1,0 mm	02		
59266 NA	1671153	Junta da lubrificação	01						











## DIVERSAS DE JUNTAS DE TURBINA





								
48372 CV	48373 CV	48375 NA	48376 NA	59266 NA	59268 NA	AAA 014/A	AAA 016/A	AAA 026/C
48896 CV Jogo de Juntas para turbina - OM 352 A / 366 A KKK / Lacon / Garret / Biaggio (chapa)								
48896 PAK CI Jogo de Juntas para turbina - OM 352 A / 366 A KKK / Lacon / Garret / Biaggio (base de cobre)								
N/Número	Original	Descrição	QT	N/Número	Original	Descrição	QT	
48372 CV	3520980880	Junta do caracol	01	59268 NA		Junta do cano	01	
48373 CV	3440987080	Junta da base	01	AAA 014/A		Arr. alumínio 14 x 22 x 1,5 mm	02	
48375 NA		Junta cano retorno	01	AAA 016/A		Arr. alumínio 16 x 22 x 1,5 mm	02	
48376 NA		Junta cano lubrificação	01	AAA 026/C		Arr. alumínio 26 x 36 x 1,0 mm	02	
59266 NA	1671153	Junta da lubrificação	01					

								
					(5,4X46,5)			
					(2,4X30,5)			
					(10,4X1,0)			
49186 F - JOGO JUNTAS TURBINA SPRINTER CDI 311/415/515 12/-BI TURBO EURO 5 - OM651 LA								







## DIVERSAS DE JUNTAS DE CÂMBIO















							
11772 NA	48071 NA	48072 NA	48073 NA				
							
48074 NA	48075 NA	48076 NA	48994 NA				
48070 NA Jogo de Juntas Câmbio Caixa ZF.9S-75 Mercedes Benz 1622/2423B / 2423K (N° ZF-1.308.298.800)							
N/Número	Original	Descrição	QT	N/ Número	N/Original	Descrição	QT
11772 NA	1290301140	Junta da tomada de força	01	48074 NA	1306302026	Junta da moringa	01
48071 NA	0501314450	Junta da carcaça	01	48075 NA	1304307177	Junta lateral do cilindro	02
48072 NA	1308301026	Junta da tampa da carcaça	01	48076 NA	1268307170	Junta da válvula de bloqueio	01
48073 NA	1308307032	Junta do cilindro	01	48994 NA	1238308166	Junta traseira do câmbio	03

							
48090 NA	48092 NA	48093 NA	48094 NA	48095 NA			
							
48096 NA	48097 NA	48098 NA	48099 NA	48994 NA			
48091 NA / PV Jogo de Juntas câmbio Cx.ZF. 16S 130 / 160 / 190 MBB 1929 / 1932 / 1933 / 1934 / 1935 / 1938 / 1941 / LS 1632 / 1938 - Volvo NL 10/12-(ZF 15S - 1650) VW Titan (orig. 1295298891/ 00900298191/6885992)							
N/Número	Original	Descrição	QT	N/ Número	N/Original	Descrição	QT
48090 NA	1295307162	Junta do câmbio	01	48096 NA	1295307076	Junta do câmbio	02
48092 NA	1296301005	Junta do câmbio	01	48097 NA	1295307054	Junta do câmbio	02
48093 NA	1296301189	Junta do câmbio	01	48098 NA	1295307053	Junta do câmbio	01
48094 NA	1297302022	Junta do câmbio	01	48099 NA	1295306041	Junta do câmbio	01
48095 NA	1296301007	Junta do câmbio	01	48994 NA	1238308166	Junta do câmbio	01







							
10500 PV	48181 PP	48182 PP	48183 PP	48184 PP			
48180 PP Jogo de Juntas Câmbio MBB OM-364 / L 608-D 1972 ED - Cx. G-20 / 24 (orig. 983085860026 / 0090298180)							
N/Número	Original	Descrição	QT	N/ Número	N/Original	Descrição	QT
10500 PV	3122611080	Junta lateral da tampa superior	01	48183 PP	3122611079	Junta tampa dianteira	01
48181 PP	3142610280	Junta da tampa superior	01	48184 PP	3122612179	Junta da tampa engren.principal	01
48182 PP	3142610480	Junta da tampa traseira interna	01				









## DIVERSAS DE JUNTAS DE CAMBIO

							
10500 PV	48181 PP	48182 PP	48183 PP	48184 PP	48695 PP		
<b>48190 PP</b> Jogo de Juntas Câmbio Mercedes Benz 709 / 710 - Cx. G-20 / 24 (orig. 6882600100)							
N/Número	Original	Descrição	QT	N/ Número	N/Original	Descrição	QT
10500 PV	3122611080	Junta lateral da tampa superior	01	48183 PP	3122611079	Junta tampa dianteira	01
48181 PP	3142610280	Junta da tampa superior	01	48184 PP	3122612179	Junta da tampa engren.principal	01
48182 PP	3142610480	Junta da tampa traseira interna	01	48695 PP		Junta caixa de câmbio	01

				
48184 PP	48294 PP	48384 PP	48386 PP	48387 PP
				
48388 PP	48389 PP	48390 PP	48391 PP	48392 PP
				
48393 PP	48395 PP	48689 PP	48988 PP	48989 PP

<b>48380 PP</b> Jogo de Juntas câmbio G-3-60 / G-3-36 OM-321/352 / 1111 / 1113 / 1513 orig. 34558670266 (juntas soltas)							
<b>48380 ENCARTEL</b> Jogo de Juntas câmbio G-3-60 / G-3-36 OM-321/352 / 1111 / 1113 / 1513 orig. 34558670266 (encartelado)							
N/Número	Original	Descrição	QT	N/ Número	N/Original	Descrição	QT
48184 PP	3122612179	Junta engrenagem principal	01	48391 PP	3212610979	Lateral tampa superior	01
48294 PP	3172611479	Junta moringa MB moderno	01	48392 PP	3212612079	Lateral tampa superior	01
48384 PV		Tampa câmbio rebaixado	01	48393 PP	3212611979	Suporte alavanca	01
48386 PP	3212611379	Tampa traseira intermediária	01	48395 PP	3212612179	Lateral tampa superior	01
48387 PP	3212610779	Tampa dianteira	01	48689 PP		Junta do câmbio	01
48388 PP	3212611279	Tampa superior	01	48988 PP	3222610280	Junta caixa mudanças	01
48389 PP	3212611479	Tampa Traseira	01	48989 PP	33726100079	Junta do câmbio	01
48390 PP	3212610280	Lateral tampa superior	01				

							
48651 NA	48652 NA	48654 NA	48655 NA	48656 NA	48657 NA	48658 NA	
<b>48650 NA</b> Jogo de Juntas Câmbio ZF S-5 6.80 MBB OF-1620 / 1318 / L-1620 / OH 1421 / OH-1318 / 1418 (orig. 0002608100 / 1290298864)							
N/Número	Original	Descrição	QT	N/ Número	N/Original	Descrição	QT
48651 NA	290395030	Junta tampa câmbio	01	48656 NA	1238308201	Junta da tomada de força	01
48652 NA	1290395395	Junta da moringa	01	48657 NA	1290395069	Junta do câmbio	01
48654 NA		Junta do câmbio	01	48658 NA	1290306371	Junta tampa lateral alavanca	01
48655 NA	1290301145	Junta do câmbio	01				

							
48389 NA	48689 NA	48691 NA	48692 CB	48693 CB			
							
48694 NA	48695 NA	48696 NA	48697 NA				
<b>48690 NA</b> Jogo de juntas câmbio G3-55 (Aplicação Veicular) MBB - 1214 / 1218 / 1414 / 1418 / 1614 / 1618 / 1714 / 1718 / LK 1620 / 1718 K / 1720 / 1720 K / 1218 - (orig. 3842604400)							
N/Número	Original	Descrição	QT	N/ Número	N/Original	Descrição	QT
48389 NA	3212611479	Junta tampa traseira	01	48694 NA		Junta da Moringa	01
48689 NA		Junta redução câmbio	01	48695 NA		Junta caixa câmbio	01
48691 NA		Junta tampa caixa	01	48696 NA		Junta da tampa traseira	01
48692 CB		Junta caixa câmbio	01	48697 NA		Junta caixa câmbio	01
48693 CB		Junta caixa câmbio	01				

## DIVERSAS DE JUNTAS DE CÂMBIO

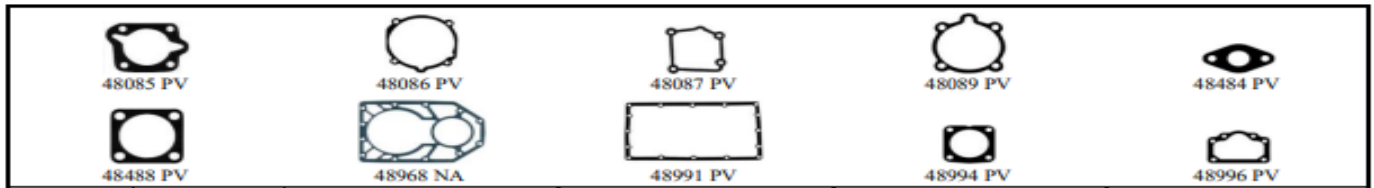

### 48960 NA Jogo de Juntas Câmbio ZF-S-1550

N/Número	Original	Descrição	QT	N/ Número	N/Original	Descrição	QT
48085 PV		Junta do câmbio	01	48488 PV	1238308165	Junta da valvula distribuição	01
48086 PV	1250302478	Junta do câmbio	01	48968 NA	ZF-0091308070	Junta da tampa traseira	01
48087 PV	1268303071	Junta do câmbio	01	48991 PV	1250306182	Junta tampa lateral	01
48089 PV	1250303135	Junta do câmbio	01	48994 PV	1238308166	Junta tampa carcaça	01
48484 PV	1205307289	Junta do tubo flange	01	48996 PV	1252307060	Junta tampa trambulador	01



### 48970 NA Jogo de Juntas Câmbio Caixa ZF S6-820 MBB LK 1123/1723 / Volvo ônibus B-7 - (NºZF -1311298.800)

N/Número	Original	Descrição	QT	N/ Número	N/Original	Descrição	QT
48657 NA	1290395069	Junta	01	48973 NA		Junta	01
48658 NA	1290306371	Junta	01	48974 NA		Junta	01
48971 NA	1311395016	Junta da tampa do câmbio	01	48994 NA	1238308166	Junta da tomada de força	01
48972 NA	1311395022	Junta	01				



### 48980 PP Jogo de Juntas Cambio Mercedes Benz OM-326 / 352 / 321 Ônibus - (orig. 983455860326)



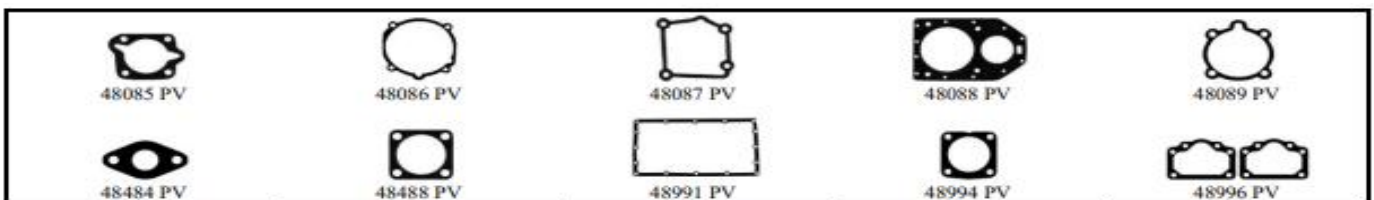







N/Número	Original	Descrição	QT	N/ Número	N/Original	Descrição	QT
48294 PP	3172611479	Junta Engrenagem principal	01	48391 PP	3212610979	Lateral tampa superior	01
48386 PP	3212611379	Tampa traseira intermediária	01	48988 PP	3222610280	Junta tampa cx. mudanças	01
48388 PP	3212611279	Tampa superior	01	48989 PP	3372610079	Junta engrenagem redução	01
48389 PP	3212611479	Junta Tampa traseira	01				













### 48981 PV Jogo de Juntas Câmbio ZF-S-6-90 / OM- 370 / Volvo B-58 - (orig. 0090298189 / 1268298889)

N/Número	Original	Descrição	QT	N/ Número	N/Original	Descrição	QT
48085 PV		Junta do câmbio	01	48484 PV	1205307289	Junta do tubo flange	01
48086 PV	1250302478	Junta do câmbio	01	48488 PV	1238308165	Junta da valvula distribuição	01
48087 PV	1268303071	Junta do câmbio	01	48991 PV	1250306182	Junta tampa lateral	01
48088 PV	0091308070	Junta traseira	01	48994 PV	1238308166	Junta tampa carcaça	01
48089 PV	1250303135	Junta do câmbio	01	48996 PV	1252307060	Junta tampa trambulador	02









## DIVERSAS DE JUNTAS DE CÂMBIO

							
48085 PV	48086 PV	48089 PV	48991 PV	48992 PV			
							
48484 PV	48488 PV	48994 PV	48995 PV	48996 PV			
<b>48982 PV Jogo de Juntas Câmbio ZF-S-6-80 + PV-80 / MBB 1519/2219 / 1520 2220 caminhão (orig. 0090298182 / 1250298882)</b>							
N/Número	Original	Descrição	QT	N/ Número	N/Original	Descrição	QT
48085 PV		Junta do câmbio	01	48992 PV	1250308002	Junta tampa traseira	01
48086 PV	1250302478	Junta do câmbio	01	48994 PV	1238308166	Junta tampa carcaça	01
48089 PV	1250303135	Junta do câmbio	01	48995 PV	1250307521	Junta	01
48484 PV	1205307289	Junta do tubo flange	01	48996 PV	1252307060	Junta tampa trambulador	02
48488 PV	1238308165	Junta da valvula distribuição	01	50486 PV	1250312222	Junta tampa dianteira	01
48991 PV	1250306182	Junta tampa superior	01				



## DIVERSAS DE JUNTAS DE DIFERENCIAL



			
48053 NA	48253 NA	48353 NA	48453 NA
Junta da tampa do diferencial A6013510080	Junta da tampa do diferencial Tinkao - VW / Mercedes 031.351.0380	Junta da tampa do diferencial Mercedes 608 / 709 324.351.0380	Junta da tampa do diferencial traseiro Mercedes 2219 383.351.0280
			
48553 NA	48653 NA	48853 NA	48950 NA
Junta da tampa do diferencial Mercedes LP 321 / L-1111 322.351.0180	Junta tpa do diferencial OF 1620 L 1418/20 -1720/21 (dif. HL5/2) 385.351.0080	Junta da tampa do diferencial MBB 1113/1313/1513/2013/2213 302.351.0180	Junta da tampa do diferencial MBB 2219 canavieiro reduzido 383.351.0480
			
48951 NA	48953 NA		
Junta da tampa do diferencial OM 355/6/ OM 355/6A/6S-1924 - LS 1924/A - 383.351.0380	Junta da tampa do diferencial Mercedes L-1519 reduzido 317.351.0280		





## DIVERSAS DE JUNTAS DE CAIXA DE TRANSFERENCIA







					
48582 NA	48583 NA	48584 NA			
48581 NA Jogo de juntas da caixa de transferência – OM-352 / 2013 / 2213 / 2218 (antiga)					
					
48682 NA	48683 NA	48684 NA	48685 NA	48686 NA	48687 GV
48681 NA / PV Jogo de juntas da Caixa de transferência – OM-366 / VG 500 (moderna)					





## DIVERSAS DE JUNTAS DE COMPRESSOR



							
48263 NA	48264 NA	48265 NA					
48260 NA Jogo de juntas para compressor Wabco - Mercedes Benz OM-355 5/6 cils. orig. 0001303920							
N/Número	N/Original	Descrição	QT	N/Número	N/Original	Descrição	QT
48263 NA	0001312079	Junta do cilindro	01	48265 NA	0001317780	Junta do cabeçote	
48264 NA	0001312179	Junta da válvula	01				

							
48342 NA	48344 NA	48875 NA					
48350 NA Jogo de juntas para compressor - Mercedes Benz OM-321 / OM-352 / OM-352 A - 4/6 cils.							
N/Número	N/Original	Descrição	QT	N/Número	N/Original	Descrição	QT
48342 NA	3211310079	Junta da camisa	01	48875 NA	3521310380	Junta	01
48344 NA	3221310279	Junta	01				

							
48457 NA	48458 S	48459 NA	48459/1 NA				
48460 NA Jogo de juntas para compressor Knorr BR 400 - Mercedes Benz OM-447 / 449							
N/Número	N/Original	Descrição	QT	N/Número	N/Original	Descrição	QT
48457 NA	4421312080	Junta da refrigeração óleo	01	48459 NA	4071310080	Junta do cabeçote	01
48458 S	4421312180	Junta	01	48459/1 NA	4421310680	Junta do cabeçote	01

							
48661 NA	48662 NA	48663 NA	ORI MBB 088	AAA 010/A	AAA 026/A		
48660 NA Jogo de juntas para compressor Wabco - Mercedes Benz OM-366							
N/Número	N/Original	Descrição	QT	N/Número	N/Original	Descrição	QT
48661 NA	8973169964	Junta do cabeçote	01	ORI MBB 088		Anel de Borracha	01
48662 NA	8973169952	Junta do cabeçote	01	AAA 010/A		Arruela	01
48663 NA	8973169952	Junta do cabeçote	01	AAA 026/A		Arruela	01

							
48671 NA	48672 NA	48673 NA	48948 NA	48954 NA			
48670 NA Jogo de juntas para compressor Knorr LK 15 - Mercedes Benz OM-366 a partir de 1993							
N/Número	N/Original	Descrição	QT	N/Número	N/Original	Descrição	QT
48671 NA	4C50702	Junta	01	48948 NA	0001311479	Junta	01
48672 NA	4C50700/1	Junta	01	48954 NA	0001311579	Junta	01
48673 NA	4C50699	Junta	01				

							
48963 NA	48964 NA						
48949 NA Jogo de juntas para compressor LK 18 (orig. 0001311679)							
N/Número	N/Original	Descrição	QT	N/Número	N/Original	Descrição	QT
48963 NA	4C50703/1	Junta	01	48964 NA	4C50704	Junta	01