

1.1/1.3/1.4 8V 4C - PEUGEOT - 106/205/306/309/205/405 : /01

1.1/1.3/1.4 8V 4C - CITROEN - CITROEN: C15/AX SPORT/ZX : /01

MTR: TU1/TU1M/TU2.4/TU3 - GAS

56207-JGCB	JG JTA MTR S/ CAB	56207-JGRS	JG RETIF MTR S/ CAB
56207-JGSC	JG JTA MTR C/ CAB DE FIBRA	56207-JGRV	JG RETIF MTR C/ CAB DE FIBRA
56207-JGML	JG JTA MTR C/ CAB DE CHAPA	56207-JGRM	JG RETIF MTR C/ CAB DE CHAPA
56207-JRSC	JG JTA MTR C/ CAB DE FIBRA E C/ RET	56207-JRRV	JG RETIF MTR C/ CAB DE FIBRA E RET
56207-JRML	JG JTA MTR C/ CAB DE CHAPA E C/ RET	56207-JRRM	JG RETIF MTR C/ CAB DE CHAPA E RET



57201 SC - 1,4 MM - 76 MM
57201 MLS - 1,6 MM - 76 MM

OPCIONAL

57201 KT - 2,6 MM - 76 MM

JTA CABEÇOTE



57226 BO - JTA TAMPA VÁLVULAS



15633 NA - JTA PARAFUSOS TV

57226 KTBO - KIT JTA TAMPA VÁLVULAS



57221 F
JTA COLETOR ESCAPE

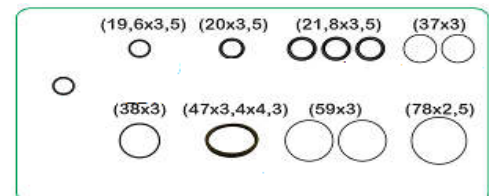

56207 KTBO - KIT BORRACHAS MOTOR

OPCIONAL



56252 NA
JTA



56253 NA
JTA



56234 NA
JTA



46759 NA
JTA



57220 NA
JTA COLETOR ADMISSÃO



56222 PAK
JTA ESCAPE



56055 NA
JTA



57232 NA
JTA TERMOSTATO

JG JTA RETIFICAÇÃO



57207 KTAR
KIT ARRUELAS MOTOR



55671 JGSI
JG ANEIS BORRACHA CAMISA



57217 NA - JTA CARTER

XXXXX-KP
KIT PARAFUSOS DO CABEÇOTE
10,00x1,50x175,00

56207-KTRT
KIT DE RETENORES DO MOTOR

RET VALVULAS-07X10X10



1213044

RET VIRABREQUIM DIANT.

42X66X08



1150098

RET COMANDO-36X50X07



1150100

RET VIRABREQUIM TRAS.

85X105X12



1112283

1.2 12V 4C - PEUGEOT - 108 / 208 / 308 / 2008 : 12/

1.2 12V 4C - CITROEN - C1 / C3 / C4 CACTUS/ DS3 : 12/

MTR: PURETECH FLEX - EB2D / ED2F(HMT / HMU / HMZ) - FLEX

57507-JGCB JG JTA MTR S/ CAB

57507-JGSC JG JTA MTR C/ CAB DE FIBRA

57507-JGML JG JTA MTR C/ CAB DE CHAPA

57507-JRSC JG JTA MTR C/ CAB DE FIBRA E C/ RET

57507-JRML JG JTA MTR C/ CAB DE CHAPA E C/ RET

57507-JRRV JG RETIF MTR C/ CAB DE FIBRA E RET

57507-JRRM JG RETIF MTR C/ CAB DE CHAPA E RET



57503 SC 1,20 MM CIL. 76 MM
57503 MLS 0,70 MM CIL. 76 MM
JTA CABEÇOTE

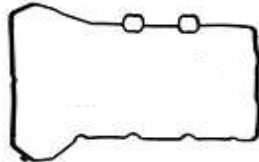

57526 BO - JUNTA TAMPA VÁLVULAS

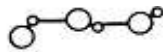

57545 BO - JUNTA DAS VELAS DA TV

57526 KTBO - KIT JUNTAS TAMPA VÁLVULAS



57523 F
JUNTA COLETOR ESCAPE



57519 JGBO
JTA COLETOR ADMISSÃO



57530 NA
JUNTA BOMBA
D'AGUA



57531 BO
JUNTA DA BOMBA
D'AGUA



57533 BO
JUNTA DO FECHAMENTO
DO BLOCO



57534 BO
JUNTA



57532 BO
JUNTA DO
TERMOSTATO

(67,5x3,2)



57537 BO
JUNTA



57536 BO
JUNTA

57507 KTBO - KIT DE BORRACHAS DO MOTOR

XXXXX-KP
KIT PARAFUSOS DO CABEÇOTE

57507-KTRT OU 57507-KTRT-F
KIT DE RETENORES DO MOTOR

RET VALVULAS-07X10X10
(4,5x8,5x13,5)



125009605

RET COMANDO

(61x75x7)



115019602

RET FLANGE TRASEIRA



57507 FR

1.4 8V 4C - PEUGEOT - 106 / 206 / 207 / 307 / 1007 / PARTNER / HOGGAR 01/

1.4 8V 4C - CITROEN - C2 / C3 / BERLINGO: 02/

MTR: TU3JP / KFW / K6D / KfV - FLEX

57206-JGCB	JG JTA MTR S/ CAB	57206-JGRS	JG RETIF MTR S/ CAB
57206-JGSC	JG JTA MTR C/ CAB DE FIBRA	57206-JGRV	JG RETIF MTR C/ CAB DE FIBRA
57206-JGML	JG JTA MTR C/ CAB DE CHAPA	57206-JGRM	JG RETIF MTR C/ CAB DE CHAPA
57206-JRSC	JG JTA MTR C/ CAB DE FIBRA E C/ RET	57206-JRRV	JG RETIF MTR C/ CAB DE FIBRA E RET
57206-JRML	JG JTA MTR C/ CAB DE CHAPA E C/ RET	57206-JRRM	JG RETIF MTR C/ CAB DE CHAPA E RET



57204 SC - 1,6 MM - CIL. 76 MM
57204 MLS - 1,6 MM - CIL. 76 MM

OPCIONAL

57204 KT - 2,6 MM - CIL. 76 MM

JTA CABEÇOTE



57226 BO - JTA TAMPA VÁLVULAS

15633 NA - JUNTAS PARAFUSOS TV

57226 KTBO
KIT JTA TAMPA VÁLVULAS



57222 F
JTA COLETOR ESCAPE



57232 NA
JTA TERMOSTATO



57219 JGBO
JTA COLETOR ADMISSÃO

OPCIONAL



56222 PAK
JTA ESCAPE



57244 KTBO
KIT JTA TERMOSTATO FLEX



57064 PAK
GAXETA ESCAPE



56234 NA
JTA



56235 NA
JTA



56233 NA
JTA



57299 F
JTA ESCAPE



57224 BO
JTA ADMISSÃO GRANDE

57206 KTBO - KIT BORRACHAS MTR

JG JTA RETIFICAÇÃO



55671 JGSI
JG ANEIS BORRACHA CAMISA



57217 NA - JTA CARTER

57206-KP
KIT PARAFUSOS DO CABEÇOTE
10.00X1.50X175.00 (X10)

57206-KTRT
KIT DE RETENORES DO MOTOR

RET VALVULAS-07X10X10



1213044

RET VIRABREQUIM DIANT.
42X66X08



1150098

RET COMANDO-36X50X07



1150100

RET VIRABREQUIM TRAS.
85X105X08



1151110

1.5 8V 4C - PEUGEOT - 208 12/ - MTR TU4M - FLEX

1.5 8V 4C - CITROEN - C3 / AIRCROSS / PICASSO : 12/ - MTR TU4M - FLEX

MTR: TU4M - FLEX

57505-JGCB JG JTA MTR S/ CAB

57505-JGSC JG JTA MTR C/ CAB DE FIBRA

57505-JGML JG JTA MTR C/ CAB DE CHAPA

57505-JRSC JG JTA MTR C/ CAB DE FIBRA E C/ RET

57505-JRML JG JTA MTR C/ CAB DE CHAPA E C/ RET

57505-JGRS JG RETIF MTR S/ CAB

57505-JGRV JG RETIF MTR C/ CAB DE FIBRA

57505-JGRM JG RETIF MTR C/ CAB DE CHAPA

57505-JRRV JG RETIF MTR C/ CAB DE FIBRA E RET

57505-JRRM JG RETIF MTR C/ CAB DE CHAPA E RET



57501 SC - 1,2 MM - CIL. 76 MM
57501 MLS - 0,7 MM - CIL. 76 MM

OPCIONAL

57501 SC-1M - 2,2 MM - CIL. 76 MM
57501 KT2 - 2,0 MM - CIL. 76 MM
57501 KT - 3,0 MM - CIL. 76 MM

JTA CABEÇOTE



46141 JGBO
JTA COLETOR ADMISSÃO



56233 NA JTA 56234 NA JTA 56235 NA JTA

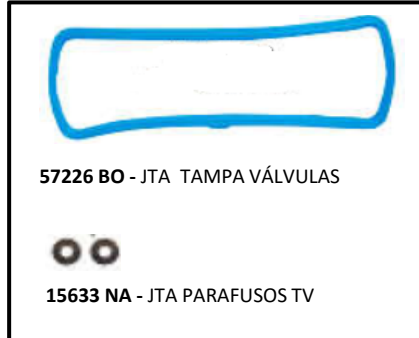

57226 BO - JTA TAMPA VÁLVULAS



15633 NA - JTA PARAFUSOS TV

57226 KTBO - KIT JTA TAMPA VÁLVULAS



57222 F
JTA COLETOR ESCAPE

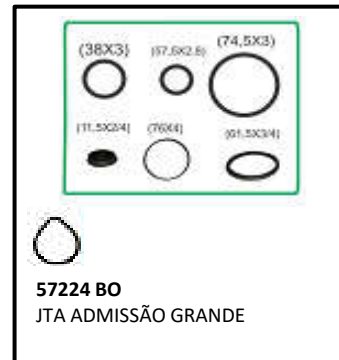

57224 BO
JTA ADMISSÃO GRANDE

57206 KTBO - KIT BORRACHAS MTR

JG JTA RETIFICAÇÃO

OPCIONAL



57244 KTBO
KIT JTA
THERMOSTATO
FLEX



56222 PAK
JTA ESCAPE



57299 F
JTA ESCAPE



55671 JGSI
JG ANEIS BORRACHA CAMISA



57217 NA - JTA CARTER

57505-KP

KIT PARAFUSOS DO CABEÇOTE
10.00X1.50X117.00 (X10)

57505-KTRT

KIT DE RETENORES DO MOTOR

RET VALVULAS-06X09X10



1219203

RET VIRABREQUIM DIANT.

42X66X08



1150098

RET COMANDO-36X50X07



1150100

RET VIRABREQUIM TRAS.

85X105X08



1151110

1.6 8V 4C - PEUGEOT - 106 94/- 206 / PARTNER 98/ - 306 93/

1.6 8V 4C - CITROEN - XSARA PICASSO 00/

MTR: TU5JP(NFX)/TU5J2 - GAS

56209-JGCB	JG JTA MTR S/ CAB	56209-JGRS	JG RETIF MTR S/ CAB
56209-JGSC	JG JTA MTR C/ CAB DE FIBRA	56209-JGRV	JG RETIF MTR C/ CAB DE FIBRA
56209-JGML	JG JTA MTR C/ CAB DE CHAPA	56209-JGRM	JG RETIF MTR C/ CAB DE CHAPA
56209-JRSC	JG JTA MTR C/ CAB DE FIBRA E C/ RET	56209-JRRV	JG RETIF MTR C/ CAB DE FIBRA E RET
56209-JRML	JG JTA MTR C/ CAB DE CHAPA E C/ RET	56209-JRRM	JG RETIF MTR C/ CAB DE CHAPA E RET



57203 SC - 1,6 MM - CIL. 76 MM
57203 MLS - 1,6 MM - CIL. 76 MM

OPCIONAL

57203 KT - 2,6 MM - CIL. 76 MM

JTA CABEÇOTE



57226 BO - JTA TAMPA VÁLVULAS



15633 NA - JTA PARAFUSOS TV

57226 KTBO - KIT JTA TAMPA VÁLVULAS



57221 F
JTA COLETOR ESCAPE



57220 NA
JTA COLETOR ADMISSÃO



57219 JGBO
JTA COLETOR ADMISSÃO



56222 PAK
JTA ESCAPE

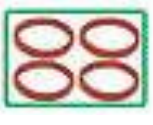

57218 JGBO
JTA COLETOR ADMISSÃO

OPCIONAL



56234 NA
JTA



56253 NA
JTA



56252 NA
JTA



46759 NA
JTA CARBURADOR



57030 CB
JTA TPA. TERMOSTATO



57232 NA
JTA TERMOSTATO

JG JTA RETIFICAÇÃO



57207 KTAR
KIT ARRUELAS MOTOR

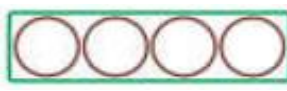

55671 JGSI
JG ANEIS BORRACHA CAMISA



57217 NA - JTA CARTER

57206-KP

KIT PARAFUSOS DO CABEÇOTE

10.00X1.50X175.00 (X10)

56207-KTRT

KIT DE RETENORES DO MOTOR

RET VALVULAS-07X10X10



1213044

RET VIRABREQUIM DIANT.

42X66X08



1150098

RET COMANDO-36X50X07



1150100

RET VIRABREQUIM TRAS.

85X105X12



1112283

1.6 8V 4C - PEUGEOT - EXPERT 18/

1.6 8V 4C - CITROEN - JUMPY 18/

MTR: DV6 HDI (TURBO DIESELI)

56808-JGCB JG JTA MTR S/ CAB
56808-JGSC JG JTA MTR C/ CAB DE FIBRA
56808-JGML JG JTA MTR C/ CAB DE CHAPA
56808-JRSC JG JTA MTR C/ CAB DE FIBRA E C/ RET
56808-JRML JG JTA MTR C/ CAB DE CHAPA E C/ RET

56808-JGRS JG RETIF MTR S/ CAB
56808-JGRV JG RETIF MTR C/ CAB DE FIBRA
56808-JGRM JG RETIF MTR C/ CAB DE CHAPA
56808-JRRV JG RETIF MTR C/ CAB DE FIBRA E RET
56808-JRRM JG RETIF MTR C/ CAB DE CHAPA E RET

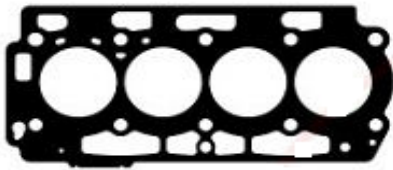

56802 SC
56802 MLS
JTA CABEÇOTE



56825 BP
JUNTA TAMPA VÁLVULAS

OPCIONAL



56849 DI
DIAFRAGMA DA TV

56825 BP DI
JUNTA TAMPA VÁLVULAS C/ DIAFRAGMA



56821 F
JUNTA COLETOR ESCAPE



56886 CV
JUNTA TURBINA

OPCIONAL



56863 PAK
GAXETA
ESCAPE



56820 JGBO
JTA COLETOR ADMISSÃO



56830 NA
JUNTA BOMBA
D'AGUA

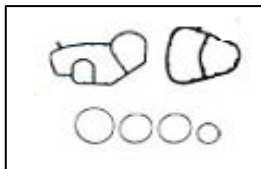

56844 KTBO
KIT BORRACHAS
FILTRÓ ÓLEO



56833 JGBO
KIT JUNTAS



56828 KTBN
KIT JUNTA TAMPA
DISTRIBUIÇÃO/BOMBA ÓLEO



56816 NA
JUNTA CARTER

XXXXX-KP
KIT PARAFUSOS DO CABEÇOTE

XXXXX-KTRT OU XXXXX-KTRT-F
KIT DE RETENORES DO MOTOR

RET HASTE VALVULAS

RET COMANDO

RET GIRABREQUIM DIANT.

RET GIRABREQUIM TRASEIRA

1.6/1.8 8V 4C - PEUGEOT - 306 / 405 / 406 / PARTNER 97/

1.6/1.8 8V 4C - CITROEN - XANTIA / XSARA / ZX / BERLINGO 98/

MTR: XU7JP/XU7JB(LFX)/XUJ5P(BFZ)- GAS

57006-JGCB JG JTA MTR S/ CAB

57006-JGSC JG JTA MTR C/ CAB DE FIBRA

57006-JRSC JG JTA MTR C/ CAB DE FIBRA E C/ RET

57006-JGRS JG RETIF MTR S/ CAB

57006-JGRV JG RETIF MTR C/ CAB DE FIBRA

57006-JRRV JG RETIF MTR C/ CAB DE FIBRA E RET

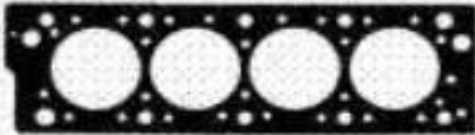

57001 SC - 1,4 MM CIL. 84 MM

OPCIONAL

57001 KT - 3,0 MM CIL. 84 MM

JTA CABEÇOTE



57028 BO - JTA TAMPA VÁLVULAS



57046 JG BO - JTA PARAFUSOS TV

57028 KTBO
KIT JTA TAMPA VÁLVULAS



57022 F
JTA COLETOR ESCAPE PARTNER



57021 F
JTA COLETOR ESCAPE

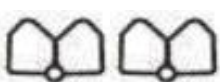

57020 JGSI
JTA COLETOR
ADMISSÃO

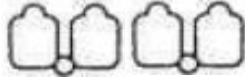

57025 JGSI
JTA COLETOR
ADMISSÃO



57122 JGSI
JTA COLETOR ADMISSÃO
PARTNER



57332 NA
JTA TERMOSTATO



57030 CB
JTA TPA.
TERMOSTATO

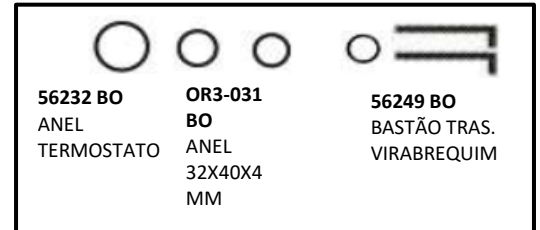

56232 BO
ANEL
TERMOSTATO

OR3-031
BO
ANEL
32X40X4
MM

56249 BO
BASTÃO TRAS.
VIRABREQUIM

57006 KTBO - KIT BORRACHAS MOTOR

JG JTA RETIFICAÇÃO



57032 NA
JTA BBA DAGUA



55671 JGSI
JG ANEIS BORRACHA CAMISA



57006 KTAR
KIT ARRUELAS MOTOR



57016 NA
JTA CARTER

57006-KP

KIT PARAFUSOS DO CABEÇOTE
11.00X1.25X174.20 (X10)

57006-KTRT

KIT DE RETENORES DO MOTOR

RET VALVULAS-08X11X10



121254

RET VIRABREQUIM DIANT.

42X62X07



1151100

RET COMANDO-36X50X07



1150100

RET VIRABREQUIM TRAS.

90X110X07



1150298

1.6 16V 4C - PEUGEOT - 206 / 1007: 01/05 - 307 01/06 - PARTNER : 03/11

1.6 16V 4C - CITROEN - C2 / C3 / C4 / BERLINGO: 00/06 - XSARA / AIRCROSS: 00/

MTR: TU5JP4 (NFU / N6A) - GAS / ALC

56208-JGCB	JG JTA MTR S/ CAB	56208-JGRS	JG RETIF MTR S/ CAB
56208-JGSC	JG JTA MTR C/ CAB DE FIBRA	56208-JGRV	JG RETIF MTR C/ CAB DE FIBRA
56208-JGML	JG JTA MTR C/ CAB DE CHAPA	56208-JGRM	JG RETIF MTR C/ CAB DE CHAPA
56208-JRSC	JG JTA MTR C/ CAB DE FIBRA E C/ RET	56208-JRRV	JG RETIF MTR C/ CAB DE FIBRA E RET
56208-JRML	JG JTA MTR C/ CAB DE CHAPA E C/ RET	56208-JRRM	JG RETIF MTR C/ CAB DE CHAPA E RET



57202 SC - 1,2 MM - CIL. 79,5 MM
57202 MLS - 0,7 MM - CIL. 79,5 MM

OPCIONAL

57202 MLS-2M - 1,4 MM - CIL. 79,5 MM
57202 MLS-3M - 2,8 MM - CIL. 79,5 MM
57202 KT - 3,0 MM - CIL. 79,5 MM

JTA CABEÇOTE



46141 JGBO - JTA ADMISSÃO

56218 BO
JTA ADMISSÃO
GRANDE

56219 KTBO - KIT JTA COLETOR ADMISSÃO



56225 BO - 2 PÇS
JTA TAMPA VÁLVULAS



56221 F
JTA COLETOR ESCAPE

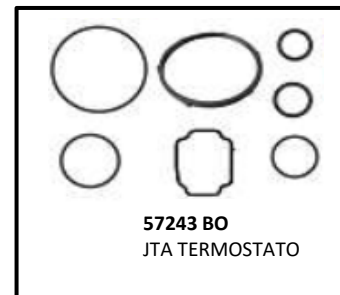

57243 BO
JTA TERMOSTATO

56208 KTBO
KIT BORRACHAS MOTOR



57299 FA
JTA ESCAPE

JG JTA RETIFICAÇÃO

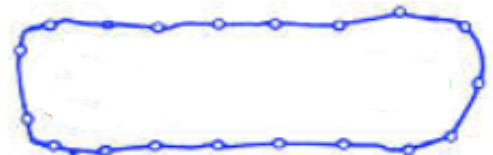

56216 BO - JTA CARTER

56208-KP
KIT PARAFUSOS DO CABEÇOTE
10.00X1.50X117.00 (X10)

56208-KTRT
KIT DE RETENORES DO MOTOR

RET VALVULAS-06X09X10



1219203

RET COMANDO-38X50X06



1150134

RET VIRABREQUIM DIANT.

42X66X08



1150098

RET VIRABREQUIM TRAS.

85X105X08



1151110

1.6 16V 4C - PEUGEOT - 208 / 308 / 3008: 09/ - 307 / PARTNER : 07/

1.6 16V 4C - CITROEN - C3 05/21 - C4 09/21 - AIRCROSS 10/21 - BERLINGO / XSARA

MTR: TU5JP4 - FLEX

56205-JGCB	JG JTA MTR S/ CAB	56205-JGRS	JG RETIF MTR S/ CAB
56205-JGSC	JG JTA MTR C/ CAB DE FIBRA	56205-JGRV	JG RETIF MTR C/ CAB DE FIBRA
56205-JGML	JG JTA MTR C/ CAB DE CHAPA	56205-JGRM	JG RETIF MTR C/ CAB DE CHAPA
56205-JRSC	JG JTA MTR C/ CAB DE FIBRA E C/ RET	56205-JRRV	JG RETIF MTR C/ CAB DE FIBRA E RET
56205-JRML	JG JTA MTR C/ CAB DE CHAPA E C/ RET	56205-JRRM	JG RETIF MTR C/ CAB DE CHAPA E RET



57202 SC - 1,2 MM - CIL. 79,5 MM
57202 MLS - 0,7 MM - CIL. 79,5 MM

OPCIONAL

57202 MLS-2M - 1,4 MM - CIL. 79,5 MM
57202 MLS-3M - 2,8 MM - CIL. 79,5 MM
57202 KT - 3,0 MM - CIL. 79,5 MM

JTA CABEÇOTE



56225 BP - (1PÇ)
JTA TAMPA VÁLVULAS



56221 F
JTA COLETOR ESCAPE

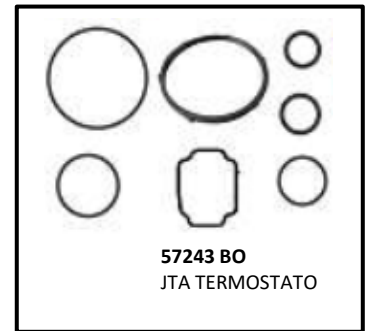

56208 KTBO - KIT BORRACHAS MOTOR

JG JTA RETIFICAÇÃO



46151 JGBO - JTA ADMISSÃO



56218 BO
JTA ADMISSÃO GRANDE

56219 KTBO - KIT JTA COLETOR ADMISSÃO

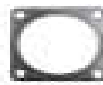

57299 FA
JTA ESCAPE

57243 BO
JTA TERMOSTATO

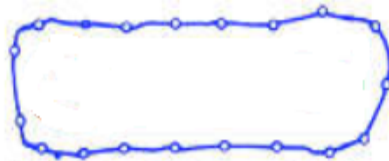

56216 BO - JTA CARTER

56208-KP
KIT PARAFUSOS DO CABEÇOTE
10.00X1.50X117.00 (X10)

56208-KTRT
KIT DE RETENORES DO MOTOR

RET VALVULAS-06X09X10



1219203

RET VIRABREQUIM DIANT.

42X66X08



1150098

RET COMANDO-38X50X06



1150134

RET VIRABREQUIM TRAS.

85X105X08



1151110

1.6 16V 4C - PEUGEOT - 207 / 208 / 308 / 408 / 508 / 2008 / 3008 / RCZ

1.6 16V 4C - CITROEN - C4 LOUNGE / C5 / DS3 / DS4 / DS5 / PICASSO GRAND / C4 PICASSO

1.6 16V 4C - MINI - COOPER S / COUNTRYMAN JOHN / COOPER WORKS / ROADSTER

MTR THP EP6 - TURBO - GAS

57506-JGCB	JG JTA MTR S/ CAB	57506-JGRS	JG RETIF MTR S/ CAB
57506-JGSC	JG JTA MTR C/ CAB DE FIBRA	57506-JGRV	JG RETIF MTR C/ CAB DE FIBRA
57506-JGML	JG JTA MTR C/ CAB DE CHAPA	57506-JGRM	JG RETIF MTR C/ CAB DE CHAPA
57506-JRSC	JG JTA MTR C/ CAB DE FIBRA E C/ RET	57506-JRRV	JG RETIF MTR C/ CAB DE FIBRA E RET
57506-JRML	JG JTA MTR C/ CAB DE CHAPA E C/ RET	57506-JRRM	JG RETIF MTR C/ CAB DE CHAPA E RET



57502 SC - 1,2 MM - CIL. 78MM
57502 MLS - 0,9 MM - CIL. 78 MM
JTA CABEÇOTE



57520 JGBO
JUNTA COLETOR
ADMISSÃO



57522 F
JUNTA
ESCAPE

OPCIONAL



57542 BO
JTA
TERMOSTATO



56226 BO - JTA TAMPA VÁLVULAS



57546 JGBO - JG VEDADORES VELAS

56226 KTBO - KIT JUNTA TV



57521 F
JUNTA COLETOR ESCAPE



57531 BO
JUNTA BBA
D'AGUA



57547-BO
VEDADOR



57548-BO
VEDADOR

57506 KTBO - KIT BORRACHAS MOTOR
JG JTA RETIFICAÇÃO



57535-KTBO - KIT FILTRO OLEO



57543-KTBO - KIT FILTRO OLEO

OPCIONAL



57516 NA
JTA CARTER

57544 KTBO - KIT SUPORTE E FILTRO OLEO

57506-KP
KIT PARAFUSOS DO CABEÇOTE
10.00X 1.50 X 151.00 MM - 10PÇS

57506-KTRT
KIT DE RETENORES DO MOTOR

RET VALV.-4,5X8,9X17,9



125009602

RET POLIA
(61X75X8)



115019602

RETENTOR GIRABREQUIM TRASEIRO
85X105X08



115029602

1.8 16V 4C - PEUGEOT - 306 / 406 : 97/

1.8 16V 4C - CITROEN - XANTIA/ZX 97/ - MTR XU7JP4 - GAS

MTR: XU7JP4 - GAS

57011-JGCB JG JTA MTR S/ CAB

57011-JGSC JG JTA MTR C/ CAB DE FIBRA

57011-JGRS JG RETIF MTR S/ CAB

57011-JGRV JG RETIF MTR C/ CAB DE FIBRA



57002 SC - 1,8 MM - CIL. 84 MM

OPCIONAL

57002 KT - 3,0 MM - CIL. 84 MM

JTA CABEÇOTE

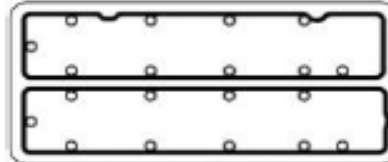

57027 KTBO - JTA TAMPA VÁLVULAS



57121 F
JTA COLETOR ESCAPE



57120 NA
JTA COLETOR ADMISSÃO



56120 JGSI
JTA COLETOR
ADMISSÃO



57033 NA
JTA
TERMOSTATO



57030 CB
JTA TPA.
TERMOSTATO



56249 BO
57011 KTBO - KIT BORRACHAS MOTOR

JG JTA RETIFICAÇÃO

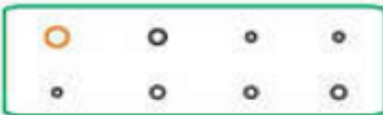

57011 KTAR
KIT ARRUELAS MOTOR



46270 JGSI
JG ANEIS BORRACHA CAMISA



57032 NA
JTA BBA
DAGUA



57016 NA - JTA CARTER

57011-KP - KIT PARAFUSOS DO CABEÇOTE

11.00X1.50X159.00 (x10)

57011-KTRT OU 57011-KTRT-2 : (RETENTOR DE HASTE DE VÁLVULAS DIFERENTE)

57011-KTRT

KIT DE RETENTORES DO MOTOR

RET VALVULAS-06X10X16,1



1250098

RET COMANDO-36X50X07



1150100

RET VIRABREQUIM DIANT.

42X62X07



1151100

RET VIRABREQUIM TRAS.

90X110X07



1150298

57011-KTRT-2

KIT DE RETENTORES DO MOTOR

RET VALVULAS-06X10X17,5



1250198

RET COMANDO-36X50X07



1150100

RET VIRABREQUIM DIANT.

42X62X07



1151100

RET VIRABREQUIM TRAS.

90X110X07



1150298

2.0 8V 4C - PEUGEOT - 306 93/97 - 405 92/04 - 406 -605 SRI 94/95

2.0 8V 4C - CITROEN - XANTIA 94/98 - EVASION / JUMPER 94/02

MTR: XU10J2C(RFX)/XU1J2U - GAS

57008-JGCB JG JTA MTR S/ CAB

57008-JGSC JG JTA MTR C/ CAB DE FIBRA

57008-JRSC JG JTA MTR C/ CAB DE FIBRA E C/ RET

57008-JGRS JG RETIF MTR S/ CAB

57008-JGRV JG RETIF MTR C/ CAB DE FIBRA

57008-JRRV JG RETIF MTR C/ CAB DE FIBRA E RET



57003 SC - 1,4 MM - CIL. 87 MM

OPCIONAL

57003 SC-1M - 2,4 MM - CIL. 87 MM

57003 KT - 3,0 MM - CIL. 87 MM

JTA CABEÇOTE

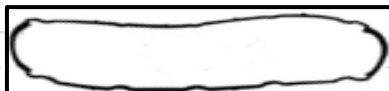

57028 BO
JTA TAMPA VÁLVULAS



57046 JG BO
JTA PARAFUSOS TV

57028 KTBO
KIT JTA TAMPA VÁLVULAS



57021 F
JTA COLETOR ESCAPE



57022 F
JTA COLETOR ESCAPE PARTNER



57019 JGSI
JTA COLETOR ADMISSÃO

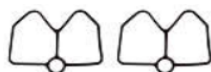

57020 JGSI
JTA COLETOR ADMISSÃO



57025 JGSI
JTA COLETOR ADMISSÃO



57033 NA
JTA TPA.TERMOSTATO



57332 NA
JTA TERMOSTATO

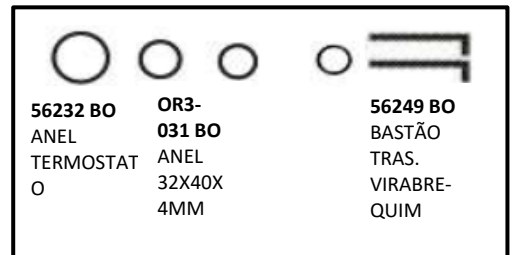

57006 KTBO - KIT BORRACHAS MOTOR

JG JTA RETIFICAÇÃO



57032 NA
JTA BBA DAGUA



46270 JGSI
JG ANEIS BORRACHA CAMISA



57006 KTAR
KIT ARRUELAS MOTOR



57016 NA
JTA CARTER

57011-KP
KIT PARAFUSOS DO CABEÇOTE
11.00X1.50X159.00 (X10)

57006-KTRT
KIT DE RETENORES DO MOTOR

RET VALVULAS-08X11X10



1212544

RET VIRABREQUIM DIANT.

42X62X07



1151100

RET COMANDO-36X50X07



1150100

RET VIRABREQUIM TRAS.

90X110X07



1150298

2.0 8V 4C - PEUGEOT - 205 / 305 / 306 / 309 / 405 / PARTNER / BOXER / EXPERT / J5 / EXPRESS / JPX: 94/01

2.0 8V 4C - SUZUKI - VITARA: 2.0 8V

MTR: **XUD7 / XUD9 / XUD9TE** - DIESEL - ASPIRADO / TURBO

56807-JGCB JG JTA MTR S/ CAB

56807-JRCB JG JTA MTR S/ CAB E C/ RET

56807-JGRS JG RETIF MTR S/ CAB

56807-JRRS JG RETIF MTR S/CAB E C/ RET



OPCIONAL

57301 SC-2M - 1,36 MM - CIL. 84 MM
57301 MLS-3M - 1,40 MM - CIL. 84 MM
57301 MLS-4M - 1,45 MM - CIL. 84 MM

JTA CABEÇOTE



57126 BO
JTA TAMPA VÁLVULAS



56821 PAK
JTA COLETOR ESCAPE/ADMISSÃO



57033 NA - JTA TPA.TERMOSTATO



56819 KTNA - JTA COLETOR ADMISSÃO



568120 JGNA - JTA COLETOR ADMISSÃO



56822 F
JTA ESCAPE



57030 CB
JTA BASE
TERMOSTATO

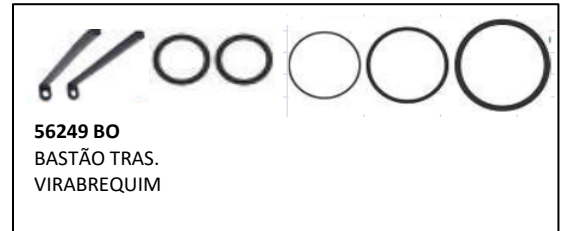

56249 BO
BASTÃO TRAS.
VIRABREQUIM

56807 KTBO - KIT BORRACHAS MOTOR

JG JTA RETIFICAÇÃO



56834 NA
JTA D AGUA



56835 NA
JTA LAT CRT



56833 NA
JTA



59832 NA
JTA TERMOSTATO

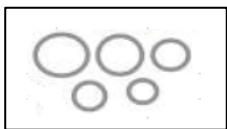

56807 KTAR - KIT ARRUELAS MOTOR



57032 NA
JTA BBA DAGUA



56843 NA
JTA MANCAL TRAS.

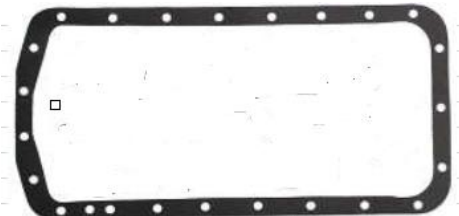

57016 NA
JTA CARTER

56807-KP (ASPIRADO)
KIT PARAFUSOS DO CABEÇOTE
12.00X1.50X123.00 (X10)

56808-KP (TURBO)
KIT PARAFUSOS DO CABEÇOTE
12.00X1.50X145.00 (X10)

56807-KTRT

KIT DE RETENORES DO MOTOR

RET VALV.-08X10,8X10,5



1250096

RET COMANDO-35X50X08



1150096

RET VIRABREQUIM DIANT.

42X62X07



1151100

RET VIRABREQUIM TRAS.

90X110X07



1150298

2.0 16V 4C - PEUGEOT - 306 / 406 / 405MI / 405TI: 92/

2.0 16V 4C - CITROEN - XANTIA / ZX:92/

MTR: XU10J4/XU10J4TE - DOHC - ASP / TURBO - GAS

57012-JGCB JG JTA MTR S/ CAB

57012-JGSC JG JTA MTR C/ CAB DE FIBRA

57012-JRSC JG JTA MTR C/ CAB DE FIBRA E C/ RET

57012-JGRS JG RETIF MTR S/ CAB

57012-JGRV JG RETIF MTR C/ CAB DE FIBRA

57012-JRRV JG RETIF MTR C/ CAB DE FIBRA E RET



57003 SC - 1,4 MM - CIL. 87 MM

OPCIONAL

57003 KT - 2,4 MM - CIL. 87 MM

JTA CABEÇOTE



57127 BO
JTA TAMPA VÁLVULAS



57123 PAK
JTA COLETOR ESCAPE



57118 NA - JTA COLETOR ADMISSÃO



57033 NA
JTA TPA. TERMOSTATO



57332 NA
JTA TERMOSTATO



56249 BO
BASTÃO TRAS.
VIRABREQUIM

57006 KTBO - KIT BORRACHAS MOTOR

JG JTA RETIFICAÇÃO



57032 NA
JTA BBA
DAGUA



46270 JGSI
JG ANEIS BORRACHA CAMISA

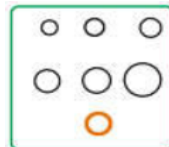

57006 KTAR
KIT ARRUELAS
MOTOR



57016 NA
JTA CARTER

XXXXX-KP
KIT PARAFUSOS DO CABEÇOTE
12,00X1,50X110,00

57012-KTRT
KIT DE RETENORES DO MOTOR

RET VALVULAS-07X10X10



1210344

RET COMANDO-36X50X07



1150100

RET VIRABREQUIM DIANT.

42X62X07



1151100

RET VIRABREQUIM TRAS.

90X110X07



1150298

2.0 16V 4C - PEUGEOT - 406 / 605 / 806: /01

2.0 16V 4C - CITROEN - XSARA / XANTIA / ZX / EVASION / XM: /00

MTR: XU10J4R(RFV) - GAS

57010-JGCB JG JTA MTR S/ CAB

57010-JGSC JG JTA MTR C/ CAB DE FIBRA

57010-JRSC JG JTA MTR C/ CAB DE FIBRA E C/ RET

57010-JGRS JG RETIF MTR S/ CAB

57010-JGRV JG RETIF MTR C/ CAB DE FIBRA

57010-JRRV JG RETIF MTR C/ CAB DE FIBRA E RET



57003 SC - 1,4 MM - CIL. 87 MM

OPCIONAL
57003 KT - 2,4 MM - CIL. 87 MM

JTA CABEÇOTE



57120 NA - JTA COLETOR ADMISSÃO



56120 JGSI - JTA COLETOR ADMISSÃO

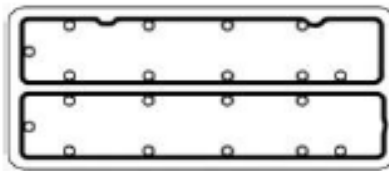

57027 BO
JTA TAMPAS VÁLVULAS



57121 F
JTA COLETOR ESCAPE



57033 NA
JTA
TERMOSTATO



57030 CB
JTA TPA.
TERMOSTATO

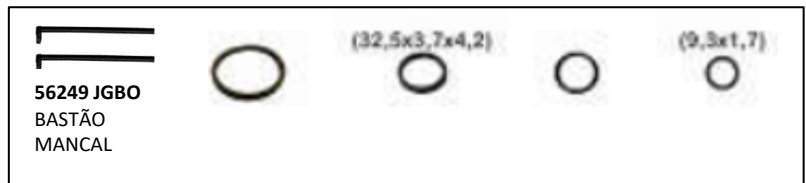

57011 KTBO - KIT BORRACHAS MOTOR

56249 JGBO
BASTÃO
MANCAL

(32,5x3,7x4,2)

(9,3x1,7)

JG JTA RETIFICAÇÃO

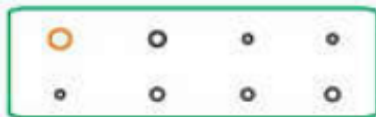

57011 KTAR
KIT ARRUELAS MOTOR



46270 JGSI
JG ANEIS BORRACHA CAMISA



57032 NA
JTA BBA
DAGUA



57016 NA
JTA CARTER

57010-KP
KIT PARAFUSOS DO CABEÇOTE
12,00X1,50X110,00

57011-KTRT
KIT DE RETENORES DO MOTOR
RET VALVULAS-06X10X16,1
RET COMANDO-36X50X07



1250098



1150100

RET VIRABREQUIM DIANT.
42X62X07



1151100

RET VIRABREQUIM TRAS.
90X110X07



1150298

2.0 16V 4C - PEUGEOT - 206 / 307 / 406 / 407 / 607 / 807: 00/

2.0 16V 4C - CITROEN - XSARA / C5: 00/ - C8 01/ - C4 02/ - PICASSO 04/

MTR: EW1014(RFN) - EW10D(RLZ) - GAS

14106-JGCB	JG JTA MTR S/ CAB	14106-JGRS	JG RETIF MTR S/ CAB
14106-JGSC	JG JTA MTR C/ CAB DE FIBRA	14106-JGRV	JG RETIF MTR C/ CAB DE FIBRA
14106-JGML	JG JTA MTR C/ CAB DE CHAPA	14106-JGRM	JG RETIF MTR C/ CAB DE CHAPA
14106-JRSC	JG JTA MTR C/ CAB DE FIBRA E C/ RET	14106-JRRV	JG RETIF MTR C/ CAB DE FIBRA E RET
14106-JRML	JG JTA MTR C/ CAB DE CHAPA E C/ RET	14106-JRRM	JG RETIF MTR C/ CAB DE CHAPA E RET



14303 SC - 1,4 MM - CIL. 85,5 MM
14303 MLS - 0,7 MM - CIL. 85,5 MM

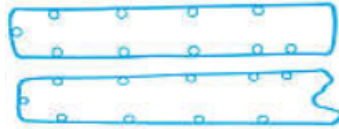

14126 KTBO - JTA TAMPA VÁLVULAS



14122 F - JTA COLETOR ESCAPE

OPCIONAL

- 14303 MLS-2M - 1,7 MM - CIL. 85,5 MM
- 14303 MLS-3M - 2,8 MM - CIL. 85,5 MM
- 14303 KT - 2,2 MM - CIL. 85,5 MM

JTA CABEÇOTE

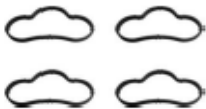

14121 JGBO
JTA COLETOR ADMISSÃO



14131 NA
JTABBA D AGUA

OPCIONAL



14120 KTNA
JTA COLETOR ADMISSÃO

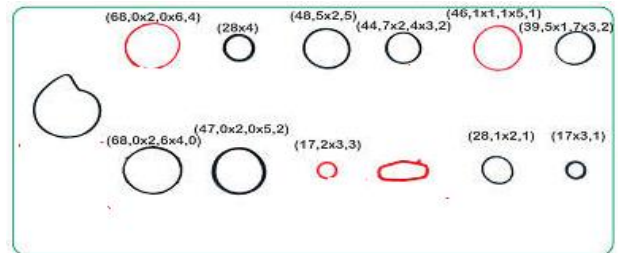

14106 KTBO - KIT BORRACHAS MOTOR

JG JTA RETIFICAÇÃO



14132 NA
JTA VÁLV. TERMOSTÁTICA

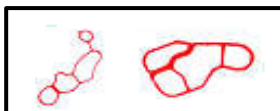

14135-KTBO
KIT RADIADOR ÓLEO



14144 NA
JTA BBA OLEO

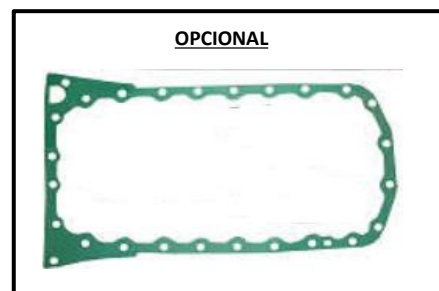

14117 PAK - JTA CARTER

56306-KP

KIT PARAFUSOS DO CABEÇOTE
11.00X1.50X126.00 (X10)

14106-KTRT

KIT DE RETENORES DO MOTOR

RET VALVULAS-06X10X17,5



1250098

RET COMANDO-38X50X06



1150100

RET VIRABREQUIM DIANT.

40X55X07



1145246

RET VIRABREQUIM TRAS.

90X110X07



1150298

2.0 16V 4C - PEUGEOT - 307 08/12 - 308 12/16 - 407 05/11 - 807 11/15

2.0 16V 4C - CITROEN - C4 04/ - C4 PALLAS: 08/21 - C5 08/10 - GRAND PICASSO: 06/

MTR: EW10A(RFJ) - FLEX

56306-JGCB	JG JTA MTR S/ CAB	56306-JGRS	JG RETIF MTR S/ CAB
56306-JGSC	JG JTA MTR C/ CAB DE FIBRA	56306-JGRV	JG RETIF MTR C/ CAB DE FIBRA
56306-JGML	JG JTA MTR C/ CAB DE CHAPA	56306-JGRM	JG RETIF MTR C/ CAB DE CHAPA
56306-JRSC	JG JTA MTR C/ CAB DE FIBRA E C/ RET	56306-JRRV	JG RETIF MTR C/ CAB DE FIBRA E RET
56306-JRML	JG JTA MTR C/ CAB DE CHAPA E C/ RET	56306-JRRM	JG RETIF MTR C/ CAB DE CHAPA E RET



14303 SC - 1,4 MM - CIL. 85,5 MM
14303 MLS - 0,7 MM - CIL. 85,5 MM

OPCIONAL

14303 MLS-2M - 1,7 MM - CIL. 85,5 MM
14303 MLS-3M - 2,8 MM - CIL. 85,5 MM
14303 KT - 2,2 MM - CIL. 85,5 MM

JTA CABEÇOTE

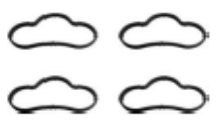

14121 JGBO
JTA COLETOR
ADMISSÃO



14131 NA
JTA BBA D'AGUA



14126 BP
JTA TAMPÁ VÁLVULAS BAQUELITE



14123 PAK
JTA COLETOR ESCAPE

OPCIONAL



14120 KTNA
JTA COLETOR
ADMISSÃO

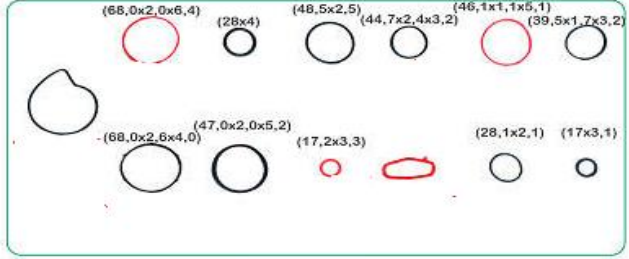

56306 KTBO - KIT BORRACHAS MOTOR

JG JTA RETIFICAÇÃO

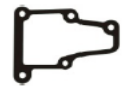

14136 NA
JTA VÁLV.TERMOSTÁTICA



14135-KTBO
KIT RADIADOR ÓLEO



14144 NA
JTA BBA ÓLEO

OPCIONAL

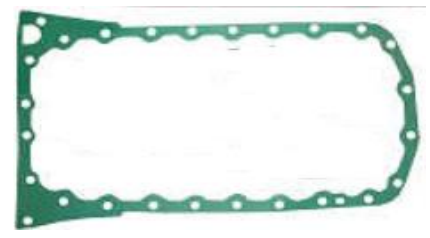

14117 PAK - JTA CARTER

56306-KP
KIT PARAFUSOS DO CABEÇOTE
11.00X1.50X126.00 (X10)

56306-KTRT
KIT DE RETENORES DO MOTOR

RET VALVULAS-06X10X17,5



1250098

RET VIRABREQUIM DIANT.

40X55X07



1145246

RE CMD:36X50X07-39X50X07



1150100 - 1150183

RET VIRABREQUIM TRAS.

90X110X07



1150298

2.3/2.5 8V 4C - 504 / 505 TD: /93 - J9: /94

MTR: XD2 / XD3 - DIESEL

56806-JGCB JG JTA MTR S/ CAB

56806-JGRS JG RETIF MTR S/ CAB



57326 CB
JTA TAMPA VÁLVULAS



57323 PAK
JTA COLETOR ADMISSÃO E ESCAPE

OPCIONAL

- 56801 SC-1M - 1,5 MM - CIL. 96 MM
- 56801 SC-2M - 1,6 MM - CIL. 96 MM
- 56801 SC-3M - 1,7 MM - CIL. 96 MM
- 56801 SC-4M - 1,8 MM - CIL. 96 MM
- 56801 KT - 3,0 MM - CIL. 96 MM

JTA CABEÇOTE



56806 KTBO - KIT BORRACHAS MOTOR



56822 PAK
JTA ESCAPE

JG JTA RETIFICAÇÃO



56843NA
JTA



56836 NA
JTA



56874 NA
JTA



56830 NA
JTA



56847 NA
JTA



56831 NA
JTA



56844 NA
JTA



56819 A
GAXETA
MANCAL
TRASEIRO

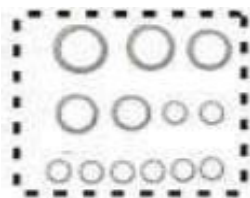

56806 KTAR
KIT ARRUELAS MOTOR



56827 NA
JTA TPA
DISTRIBUIÇÃO



56829 NA
JTA
DISTRIBUIÇÃO



56828 NA
JTA DISTRIBUIÇÃO
INTERNA



57316 NA
JTA CARTER

56806 KP-1 OU 56806 KP-2
KIT PARAFUSOS DO CABEÇOTE

- 11.00X1.25X97.50(X8)
- 11.00X1.50X107.00 (X7)
- 11.00X1.50X120.00 (X7)

- 11.00X1.50X107.00 (X15)
- 11.00X1.50X120.00 (X7)

56806-KTRT
KIT DE RETENORES DO MOTOR
RET VALVULAS-08X11X10



1212544

RET GIRABREQUIM DIANTEIRO-45X60X07



1150048

DIVERSAS JOGOS DE JUNTAS DO MOTOR

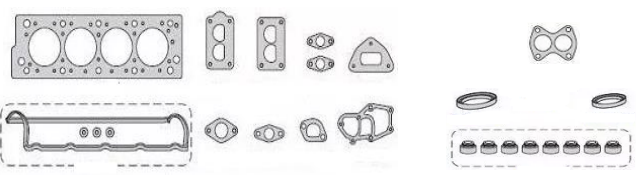

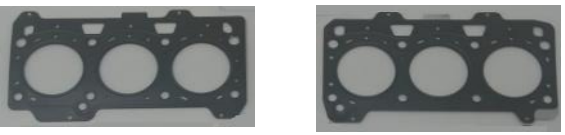
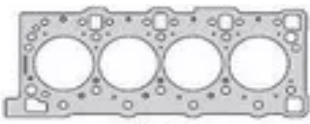

 <p>57009 JRRV</p>		
<p>JOGO DE JUNTAS SUPERIOR 306/405 1.9 8V MTR XU92C</p>		

 <p>57406 JRSC</p>	
<p>JOGO DE JUNTAS DO MOTOR BOXER 2.5 12V 4C DIESEL - 605 TURBO MOTOR DJ5T-TBA</p>	



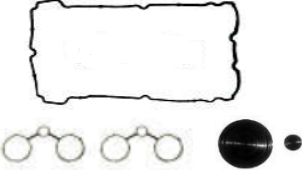

DIVERSAS JUNTA DO CABEÇOTE

 <p>56401 MLS</p>	 <p>57401 SC</p>	
<p>JTA CAB 307/407 3.0 16V V6 - PAR</p>	<p>JUNTA DO CABEÇOTE BOXER 2.5 12V 4C DIESEL 605 TURBO MOTOR DJ5T-TBA</p>	



DIVERSAS JUNTA TAMPA DE VÁLVULAS

 <p>14227 BO</p>	 <p>56225-BP-2</p>	 <p>56226 KTBO DI</p>	 <p>57426 BO</p>
<p>JUNTA DA TAMPA DE VÁLVULAS: 306/405/XANTIA 1.6/8/9 8V.../98 XU92C</p>	<p>JTA TAMPA VÁLVULAS 206/307/308/XSA/C31.616V 07/BAQUELITE -2 PC</p>	<p>JUNTA TAMPA VÁLVULAS 207/8/308/408/2008 1.616V 06/RC2-THP C/DIAFRAGMA</p>	<p>JTA TAMPA VÁLVULAS BOXER 2.5 12V 4C DIESEL 605 TURBO MOTOR DJ5T-TBA</p>



DIVERSAS DIAFRAGMA DA TAMPA DE VÁLVULAS

 <p>56349-DI/4</p>	 <p>57281 DITV</p>	 <p>57549 DI</p>	 <p>57581 KTDI</p>
<p>DIAFRAGMA TV PEUGEOT 307 2.0 16V 06/</p>	<p>DIAFRAGMA DO SUSPIRO DA TAMPA DE VÁLVULAS 307/406/407/C4/C5/PICASSO 55,71 MM</p>	<p>DIAFRAGMA MAIOR TV PEUGEOT/CITROEN: 1.2 12V 3CIL. - PURETECH HMY EB2M ZMZ</p>	<p>KIT DIAFRAGMA 308/408/C4/5-DS3/DS4/DS5/MINI TODOS: 1.6 16V TURBO GAS/FLEX 77 MM</p>

DIVERSAS COLETOR DE ESCAPE

			
56220-F	57421 CV		
JG JUNTA COL ETOR106/206/306 1.0/1.6 8V - 2 PÇS	JUNTA COL ESCAPE BOXER 2.5 12V 4C DIESEL 605 TURBO - MOTOR DJ5T-TBA		

DIVERSAS COLETOR DE ADEMISSÃO

			
56219 KTBO	57420 NA		
KIT JUNTA ADMISSÃO 206/307/XSARA/C3 1.6 16V 00/ TU5JP - 5 PÇS	JUNTA DA ADMISSÃO BOXER 2.5 12V 4C DIESEL 605 TURBO MOTOR DJ5T-TBA		

DIVERSAS ESCAPE

			
56223 F			
JUNTA DO ESCAPE 106/206/306: 1.6 8V 93/ MOTOR TU5JP/ TU5J2			

DIVERSAS GAXETA ESCAPE











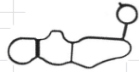

			
14164 PAK	14263 PAK	56063 PAK	56263 PAK
GAXETA DE ESCAPE C3/ PICASSO 1.6 16V 06/ 46X60X9	GAXETA DE ESCAPE: XSARA/XANTIA/ZX 1.8/2.0 67X79X15MM	GAXETA ESCAPE PEUGEOT 206/307 1.0/1.6 16V 06/- 46X59X15	GAXETA DE ESCAPE 206 / 307 1.0/1.6 16V 46 X 60 X 10

			
57034 PAK	57063 PAK	57135 PAK	57563 PV
306/405/6/BERL/XSA/PART/ 1.8/2.0 8/16V - XU7JP 66,5 X 79,5 X 15	GAXETA DE ESCAPE XSARA 2.0 - 71 X 83 X 13,5	GAXETA DE ESCAPE 306 16V (TODOS) 71 X 83 X 14	GAXETA ESCAPE 308/408/3008/C4/5- DS3/4/5-MINI COOPER1.616V THP

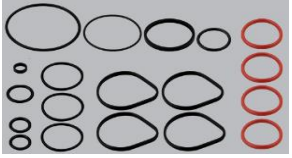
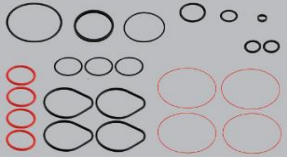

DIVERSAS DE CARTER

			
56217-NA			
JUNTA CARTER 206/307/ XSARA/C3 1.6 16V 00/TU5JP-PH			

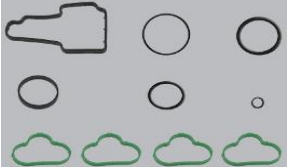
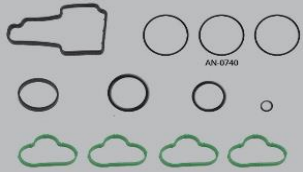
DIVERSAS

 <p>14130 BO</p>	 <p>14133 BO</p>	 <p>14134 BO</p>	 <p>14137 NA</p>
<p>JUNTA DA BOMBA D'AGUA 307406/206/XSARA /PICASSO 2.0 16V</p>	<p>JUNTA DO RADIADOR DE ÓLEO QUADRADO: C4/C5/PICASSO 2.0 16V 05/</p>	<p>JUNTA DA BOMBA DE ÓLEO: C4/C5/PICASSO 20. 16V 05/</p>	<p>JUNTA TERMOSTATO PEUGEOT 2.0 16V - C/ FLANGE 07/</p>
 <p>14138 BO</p>	 <p>14143 BO</p>	 <p>56232 BO</p>	 <p>56209-KTBO</p>
<p>JUNTA TERMOSTATO PICASSO 2.0 16V - 07/ - BORRACHA</p>	<p>VED SENSOR TEMP D'AGUA CLIO/MEGANE/LAGUNA 1.6/2.0 16V - K4M / F4P / F4R</p>	<p>VEDADOR VÁLVULA TERMOSTÁTICA PEUGEOT/CITROEN 1.6/1.8 8V</p>	<p>KIT VEDADORES MOTOR 106/206/306 1.6 8V MTR TU5JP- TU5J2- KIT 23 PÇS</p>
 <p>56209-KTBO-01</p>	 <p>(62X4X2,6) 56246 BO</p>	 <p>56249-BO</p>	 <p>57245 KTBO</p>
<p>KIT VEDADORES MOTOR 106/206/306 1.6 8V MTR TU5JP- TU5J2- KIT 19 PÇS</p>	<p>JUNTA TROCADOR CALOR 206/307/XSA/C3/1.6 16V 01/</p>	<p>GAXETA DE ESCAPE XSARA 2.0 71 X 83 X 13,5</p>	<p>GAXETA DE ESCAPE 306 16V (TODOS) 71 X 83 X 14</p>
 <p>57240 KTBO</p>	 <p>57241 KTBO</p>	 <p>57243 BO</p>	 <p>56306-KTBO-SUP/88</p>
<p>KIT DE BORRACHA DA BASE ÓLEO 206/207/C3/PIC/ 1.4 8V 1.6 16V</p>	<p>KIT DE BORRACHAS DA BASE FILTRO DE ÓLEO 207/307/308 1.4 8V - 1.6 16V</p>	<p>VEDADOR VÁLVULA TERMOSTÁTICA 206/307/C3 AIRCROSS: 1.6 16V</p>	<p>KIT VEDADORES MOTOR SUPERIOR 307/C4/C5 2.0 16V 06/-10 PÇS</p>
 <p>56306-KTBO-SUP-01/88</p>			
<p>KIT VEDADORES MOTOR SUPERIOR 307/C4/C5 2.0 16V 06/-12 PÇS</p>			

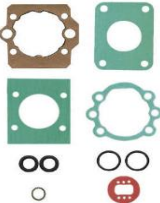
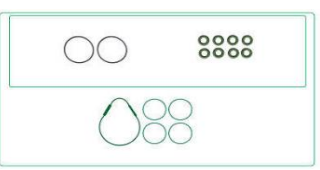
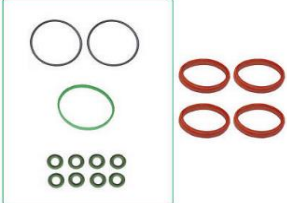
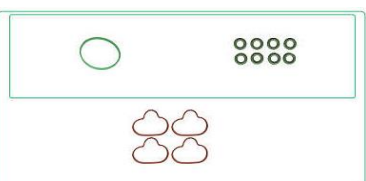
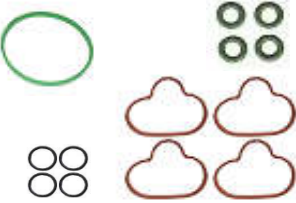
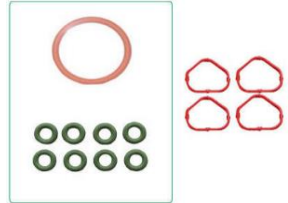
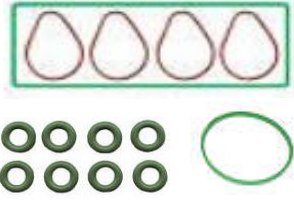
DIVERSAS INJEÇÃO

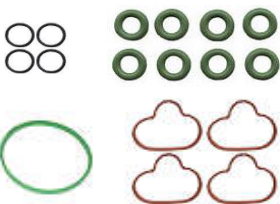
 <p>57050 KTNB</p>	 <p>56260 KTBO</p>	 <p>57270-KTBO</p>	 <p>56350 KTBO</p>
<p>KIT INJEÇÃO ELETRONICA TBI S POINT PEUGEOT 205 XSI 1.4 BOSCH</p>	<p>KIT INJEÇÃO ELETRÔNICA C/ COLETOR ADMISSÃO M POINT PEUGEOT 106/206306 /93: XSARA 97/:1.6 8V 01/..</p>	<p>KIT INJEÇÃO ELETRONICA MULT POINT 206/307 PARTNER 97/-AIRCROSS/C3/C4 BERLINGO/XSARA: 00/</p>	<p>KIT INJEÇÃO ELETRONICA MULT POINT 206/307/406/407/PICASSO: 2.0 16V</p>
 <p>56360 KTBO</p>	 <p>15172 KT BO</p>	 <p>56370 KTBO</p>	 <p>56380 KTBO</p>
<p>KIT INJEÇÃO ELETRONICA MULT POINT 206/307/406/407/PICASSO: 2.0 16V</p>	<p>KIT INJEÇÃO ELETRONICA MULT POINT 206 1.0 16V 01</p>	<p>KIT INJEÇÃO ELETRONICA MULT POINT 306/406/EVASION/XSARA</p>	<p>KIT INJEÇÃO ELETRÔNICA MULT POINT 306/405/406 97/ XSARA/BERLINGO/PARTNER 98/ XU5JP / XU7JP</p>
 <p>56390 KTBO</p>			
<p>KIT INJEÇÃO ELETRÔNICA MULT POINT 307/308 407/C4/C5 EW10A RFJ</p>			