

1.0 8V 4C - KA 97/99 - FIESTA 96/99

MTR: ENDURA E - GAS

11208-JGCB	JG JTA MTR S/ CAB	11208-JGRS	JG RETIF MTR S/ CAB
11208-JGSC	JG JTA MTR C/ CAB DE FIBRA	11208-JGRV	JG RETIF MTR C/ CAB DE FIBRA
11208-JRSC	JG JTA MTR C/ CAB DE FIBRA E C/ RET	11208-JRRV	JG RETIF MTR C/ CAB DE FIBRA E RET
11208-JGSAL	JG JTA MTR C/ CAB DE FIBRA (CRT ALÚMINIO)		
11208-JRSAL	JG JTA MTR C/ CAB DE FIBRA E C/ RET(CRT AL)		

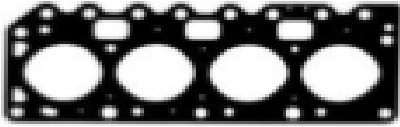

11201 SC - 1,6 MM - CIL. 70 MM

OPCIONAL

11201 KT - 2,6 MM - CIL. 70 MM

JTA CABEÇOTE

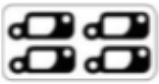

11137 PAK
JTA COLETOR ESCAPE



11126 CB
JTA TAMPA VALVULAS

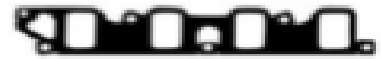

11221 PAK
JTA COLETOR ADMISSÃO



11127 PAK
JTA ESCAPE



11132 NA
JTA VALV.
TERMOSTÁTICA

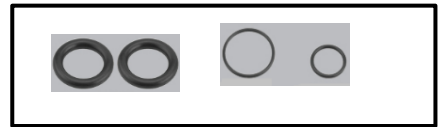

11208 KTBO - KIT VEDADORES MOTOR

JG JTA RETIFICAÇÃO



11129 NA
JTA DISTRIBUIÇÃO E BBA
D'AGUA



11130 NA
JTA DISTRIBUIÇÃO TRASEIRO



11125 NA
JTA BOMBA AGUA



11146 NA
JTA BBA ÓLEO



261420
ANEL BUJÃO CARTER

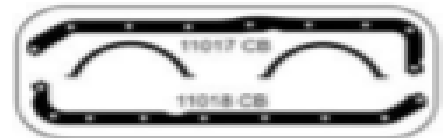

11216 CB
JTA CARTER

11208-KP
KIT PARAFUSOS DO CABEÇOTE
11.00X1.50X120.00 (X10)

11208-KTRT
KIT DE RETENORES DO MOTOR
RET VALVULAS-07X11X10,5



1212919

RET. DIANT GIRABREQUIM - RET. GIRABREQUIM TRASEIRO

36,5X52,48X08

79X95,25X11,11



1135167



1135166

1.0 8V 4C - KA 99/14 - FIESTA: 99/14

MTR: ZETEC ROCAN

11004-JGCB	JG JTA MTR S/ CAB	11004-JGRS	JG RETIF MTR S/ CAB
11004-JGSC	JG JTA MTR C/ CAB DE FIBRA	11004-JGRV	JG RETIF MTR C/ CAB DE FIBRA
11004-JGML	JG JTA MTR C/ CAB DE CHAPA	11004-JGRM	JG RETIF MTR C/ CAB DE CHAPA
11004-JRSC	JG JTA MTR C/ CAB DE FIBRA E C/ RET	11004-JRRV	JG RETIF MTR C/ CAB DE FIBRA E RET
11004-JRML	JG JTA MTR C/ CAB DE CHAPA E C/ RET	11004-JRRM	JG RETIF MTR C/ CAB DE CHAPA E RET

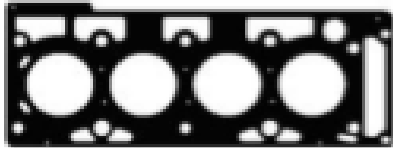

11001 SC - 1,2 MM - CIL. 70,5 MM
11001 MLS - 0,5 MM - CIL. 70,5 MM

OPCIONAL

11001 SC-2M - 2,0 MM - CIL. 70,5 MM
11001 KT - 3,0 MM - CIL. 70,5 MM
11001 MLS-1M - 1,0 MM - CIL. 70,5 MM
11001 MLS-2M - 1,2 MM - CIL. 70,5 MM
11001 MLS-3M - 1,5 MM - CIL. 70,5 MM

JTA CABEÇOTE



11122 OR
JTA COLETOR ESCAPE

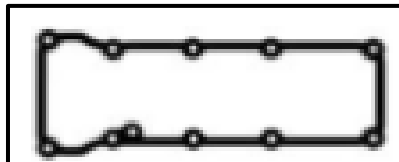

11626 BO
JTA TAMPA VALVULAS



11047 BO
VEDADOR RESPIRO ÓLEO

11626 KTBO
KIT JTA TAMPA VALVULAS



11425 OR
JTA ESCAPE



11040 NA
JTA SUPORTE
BBA ÓLEO



11121 JGBO
JTA COLETOR ADMISSÃO

OPCIONAL



11092 BO
VEDADOR
VÁLVULA
DESVIO



11843 BO
JTA CARÇAÇA
TERMOSTÁTO



11087 BO
ANEL
TERMOSTATO



OR1-117
ANEL ORING
20,29 X 2,62

11004 KTBO 01 - KIT VEDADORES MOTOR

JG JTA RETIFICAÇÃO



11429 NA
JTA DISTRIBUIÇÃO E
BBA D'AGUA



11016 BP
JTA CARTER

11004-KP
KIT PARAFUSOS DO CABEÇOTE

11.00X1.50X158.00 (X10)
8.00X1.25X45.00(X2)

11004-KTRT 11004 KTRT-F (com ret flange tras.)
KIT DE RETENORES DO MOTOR

RET HASTE VALVULAS



1230045

RET. DIANT GIRABREQUIM - FLANGE TRASEIRO
40X62X7,5



1130045



11004 FR

1.0 8V 4C - FIESTA / ECOSPORT 02/05

MTR: ZETEC ROCAN SUPERCHARGER - GAS

11006-JGCB	JG JTA MTR S/ CAB	11006-JGRS	JG RETIF MTR S/ CAB
11006-JGSC	JG JTA MTR C/ CAB DE FIBRA	11006-JGRV	JG RETIF MTR C/ CAB DE FIBRA
11006-JGML	JG JTA MTR C/ CAB DE CHAPA	11006-JGRM	JG RETIF MTR C/ CAB DE CHAPA
11006-JRSC	JG JTA MTR C/ CAB DE FIBRA E C/ RET	11006-JRRV	JG RETIF MTR C/ CAB DE FIBRA E RET
11006-JRML	JG JTA MTR C/ CAB DE CHAPA E C/ RET	11006-JRRM	JG RETIF MTR C/ CAB DE CHAPA E RET

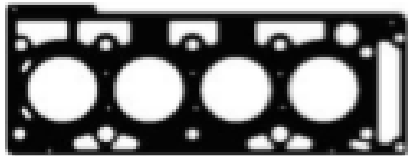

11001 SC - 1,2 MM - CIL. 70,5 MM
 11001 MLS - 0,5 MM - CIL. 70,5 MM

OPCIONAL

11001 SC-2M - 2,0 MM - CIL. 70,5 MM
 11001 KT - 3,0 MM - CIL. 70,5 MM
 11001 MLS-1M - 1,0 MM - CIL. 70,5 MM
 11001 MLS-2M - 1,2 MM - CIL. 70,5 MM
 11001 MLS-3M - 1,5 MM - CIL. 70,5 MM

JTA CABEÇOTE



11123 F
 JUNTA COLETOR ESCAPE

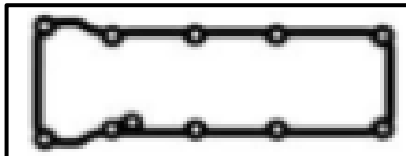

11626 BO
 JTA TAMPA VALVULAS



11047 BO
 VEDADOR RESPIRO ÓLEO

11626 KTBO
 KIT JTA TAMPA VALVULAS



11425 OR
 JTA ESCAPE



11040 NA
 JTA SUPORTE BBA ÓLEO



11120 JGBO
 JUNTA COLETOR ADMISSÃO

OPCIONAL



11092 BO
 VEDADOR VÁLVULA DESVIO



11843 BO
 JTA CARÇAÇA TERMOSTATO



11087 BO
 ANEL TERMOSTATO



OR1-117
 ANEL ORING 20,29 X 2,62

11004 KTBO 01 - KIT VEDADORES MOTOR

JG JTA RETIFICAÇÃO



11429 NA
 JTA DISTRIBUIÇÃO E BBA D'AGUA



11016 BP
 JTA CARTER

11004-KP
 KIT PARAFUSOS DO CABEÇOTE
 11.00X1.50X158.00 (X10)
 8.00X1.25X45.00(X2)

11004-KTRT 11004 KTRT-F (com ret flange tras.)
 KIT DE RETENORES DO MOTOR
 RET HASTE VALVULAS



(6x11x20)
1230045

RET. DIANT GIRABREQUIM - FLANGE TRASEIRO
 40X62X7,5



1130045



11004 FR

1.0 12V 3C - KA / KA+ - NEW FIESTA: 14/18

MTR: ECOBOOSTER TIVCT / M2DA / M1DA - FLEX

12505-JGCB	JG JTA MTR S/ CAB	12505-JGRS	JG RETIF MTR S/ CAB
12505-JGSC	JG JTA MTR C/ CAB DE FIBRA	12505-JGRV	JG RETIF MTR C/ CAB DE FIBRA
12505-JGML	JG JTA MTR C/ CAB DE CHAPA	12505-JGRM	JG RETIF MTR C/ CAB DE CHAPA
12505-JRSC	JG JTA MTR C/ CAB DE FIBRA E C/ RET	12505-JRRV	JG RETIF MTR C/ CAB DE FIBRA E RET
12505-JRML	JG JTA MTR C/ CAB DE CHAPA E C/ RET	12505-JRRM	JG RETIF MTR C/ CAB DE CHAPA E RET



12502 MLS - 0,55 MM - CIL 73 MM
12502 SC - 1,20 MM - CIL 73 MM

OPCIONAL

12502-MLS-1M - 1,00 MM - CIL 73 MM
12502-MLS-2M - 1,20 MM - CIL 73 MM
12502-KT - 2,20 MM - CIL 73 MM

JTA CABEÇOTE



12524 MLS
JUNTA CATALIZADOR



12542 MLS
JTA BOMBA VÁCUO

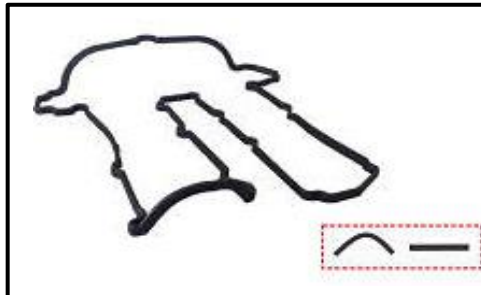

12527 BO
JTA TAMPA VÁLVULAS



12523 MLS
JUNTA COLETOR ESCAPE



12519 JGBO - JTA COLETOR ADMISSÃO



12539 BO
JUNTA BBA
D'AGUA



12580 BO
ANEL CORPO
BORBOLETA



12581 BO
JUNTA TERMOSTATO



12583 BO
JUNTA

12505 KTBO - KIT VEDADORES MOTOR

JG JTA RETIFICAÇÃO

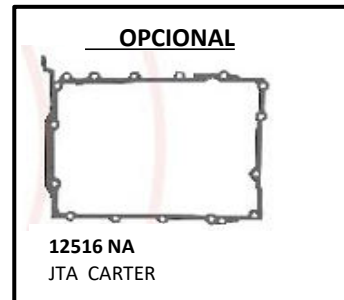

12516 NA
JTA CARTER

12505-KP
KIT PARAFUSOS DO CABEÇOTE
10.00X1.50X105.00(X8)

12505-KTRT OU 12505 KTRT-F (com ret flange tras.)
KIT DE RETENORES DO MOTOR
RET VALVULAS-5X9,5X18



1230090

FLANGE TRASEIRO



12505 FR

RET DIANT GIRABREQUIM

56X70X08



1122656

1.0 12V 3C - KA / KA+: AGOSTO 18/21

MTR: ECOBOOSTER TIVCT / M2DA / M1DA - FLEX

12509-JGCB	JG JTA MTR S/ CAB	12509-JGRS	JG RETIF MTR S/ CAB
12509-JGSC	JG JTA MTR C/ CAB DE FIBRA	12509-JGRV	JG RETIF MTR C/ CAB DE FIBRA
12509-JGML	JG JTA MTR C/ CAB DE CHAPA	12509-JGRM	JG RETIF MTR C/ CAB DE CHAPA
12509-JRSC	JG JTA MTR C/ CAB DE FIBRA E C/ RET	12509-JRRV	JG RETIF MTR C/ CAB DE FIBRA E RET
12509-JRML	JG JTA MTR C/ CAB DE CHAPA E C/ RET	12509-JRRM	JG RETIF MTR C/ CAB DE CHAPA E RET



12502 MLS - 0,55 MM - CIL 73 MM
12502 SC - 1,20 MM - CIL 73 MM

OPCIONAL

12502-MLS-1M - 1,00 MM - CIL 73 MM
12502-MLS-2M - 1,20 MM - CIL 73 MM
12502-KT - 2,20 MM - CIL 73 MM

JTA CABEÇOTE



12524 MLS
JUNTA CATALIZADOR



12542 MLS
JTA BOMBA VÁCUO



12529 BO
JTA TAMPA VÁLVULAS



12523 MLS
JTA COLETOR ESCAPE



12519 JGBO
JTA COLETOR ADMISSÃO

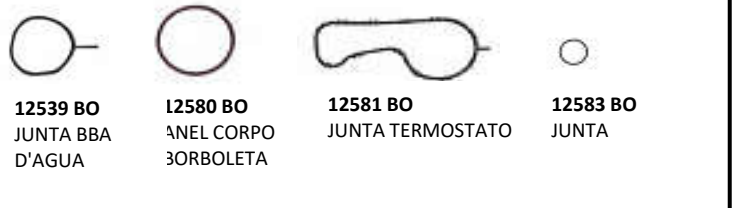

12539 BO
JUNTA BBA
D'AGUA

12580 BO
ANEL CORPO
3ORBOLETA

12581 BO
JUNTA TERMOSTATO

12583 BO
JUNTA

12505 KTBO
KIT VEDADORES MOTOR

JG JTA RETIFICAÇÃO

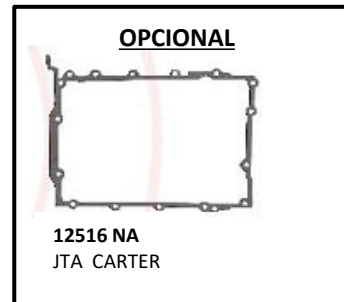

12516 NA
JTA CARTER

12505-KP
KIT PARAFUSOS DO CABEÇOTE
10.00X1.50X105.00(X8)

12505-KTRT OU 12505 KTRT-F (com ret flange tras.)
KIT DE RETENORES DO MOTOR
RET VALVULAS-5X9,5X18



1230090

FLANGE TRASEIRO



12505 FR

RET DIANT GIRABREQUIM
56X70X08



1122656

1.0 12V 3C - NEW FIESTA 16/18

MTR: ECOBOOSTER GTDI - GAS

12510-JGCB	JG JTA MTR S/ CAB	12510-JGRS	JG RETIF MTR S/ CAB
12510-JGSC	JG JTA MTR C/ CAB DE FIBRA	12510-JGRV	JG RETIF MTR C/ CAB DE FIBRA
12510-JGML	JG JTA MTR C/ CAB DE CHAPA	12510-JGRM	JG RETIF MTR C/ CAB DE CHAPA
12510-JRSC	JG JTA MTR C/ CAB DE FIBRA E C/ RET	12510-JRRV	JG RETIF MTR C/ CAB DE FIBRA E RET
12510-JRML	JG JTA MTR C/ CAB DE CHAPA E C/ RET	12510-JRRM	JG RETIF MTR C/ CAB DE CHAPA E RET



12502 MLS - 0,55 MM - CIL 73 MM
12502 SC - 1,20 MM - CIL 73 MM

OPCIONAL

12502-MLS-1M - 1,00 MM - CIL 73 MM
12502-MLS-2M - 1,20 MM - CIL 73 MM
12502-KT - 2,20 MM - CIL 73 MM

JTA CABEÇOTE



12524 MLS
JUNTA CATALIZADOR



12540 MLS
JUNTA BBA D'AGUA



12542 MLS
JTA BOMBA VÁCUO

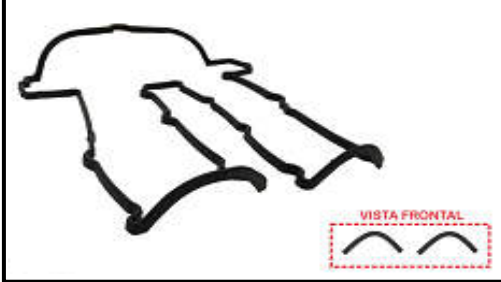

12546 BO
JTA TAMPA VÁLVULAS

VISTA FRONTAL



12552 MLS
JUNTA COLETOR ESCAPE



12550 JGBO
JTA COLETOR ADMISSÃO



12539 BO
JUNTA BBA D'AGUA



12580 BO
ANEL CORPO BORBOLETA



12581 BO
JUNTA TERMOSTATO



12583 BO
JUNTA

12505 KTBO - KIT VEDADORES MOTOR

JG JTA RETIFICAÇÃO

OPCIONAL

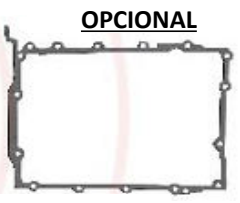

12516 NA
JTA CARTER

12505-KP
KIT PARAFUSOS DO CABEÇOTE
10.00X1.50X105.00(X8)

12505-KTRT OU 12505 KTRT-F (com ret flange tras.)
KIT DE RETENORES DO MOTOR

RET VALVULAS-5X9,5X18



1230090

FLANGE TRASEIRO



12505 FR

RET DIANT GIRABREQUIM
56X70X08



1122656

1.0/1.3 8V - FORD - ESCORT / DEL REY: 1.3 83/ - HOBBY 1.0 94/96

1.0/1.3 8V - VW - GOL 1000 93/96

MTR: CHT / AE - GAS/ALC

11806-JGCB JG JTA MTR S/ CAB

11806-JGSC JG JTA MTR C/ CAB DE FIBRA

11806-JRSC JG JTA MTR C/ CAB DE FIBRA E C/ RET

11806-JGRS JG RETIF MTR S/ CAB

11806-JGRV JG RETIF MTR C/ CAB DE FIBRA

11806-JRRV JG RETIF MTR C/ CAB DE FIBRA E RET

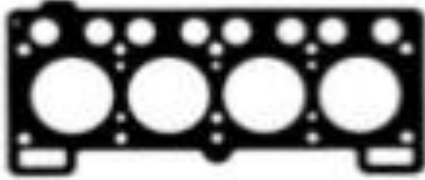

11801 SC - 1,4 MM - CIL. 73 MM

OPCIONAL

11801 KT - 2,4 MM - CIL. 73 MM

11801 TB - 1,9 MM - CIL. 73 MM

JTA CABEÇOTE



11226 BO - JTA TAMPA VÁLVULAS



11635 JGBO
JG BORRACHAS TAMPA VÁLVULAS

11226 KTBO
KIT JTA TAMPA VÁLVULAS

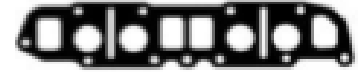

11821 PAK
JTA COLETOR ESCAPE



11822 PAK
JUNTA DO
ESCAPE



46024 PAK
JTA DO
ESCAPE



11655 NA
JTA BBA D AGUA



11831 NA
ITA BBA DAGUA



11830 NA
JTA TRAS.
CABEÇOTE



11030 NA
JTA PEQUENA
ADMISSÃO



11032 NA
JTA VÁLVULA
TERMOSTATICA



11625 FL
JTA CAMISA

JG JTA RETIFICAÇÃO



261420
ANEL BUJÃO CARTER



11636 GV
JTA BBA ÓLEO



11632 CB
JTA TAMPA ÓLEO



11833 GV
JTA DISTRIBUIDOR



11832 NA
JTA BBA AGUA



11272 NA
JTA BBA
COMBUSTIVEL



11228 PV
JTA DISTRIBUIÇÃO



11816 CB
JTA CARTER

11807-KP

KIT PARAFUSOS DO CABEÇOTE
10.00X1.50X100.00 (X10)

11807-KTRT

KIT DE RETENORES DO MOTOR

RET HASTE VÁLVULAS

(7x11x10,5)



1212919

RET. DIANT GIRABREQUIM - RET. GIRABREQUIM TRASEIRO

(35x50x8)



1112456

(82x105x12)



1111945

1.3 8V 4C - KA 97/99 - FIESTA 95/99 - COURIER 97/99

MTR: ENDURA E (HCS)

11209-JGCB	JG JTA MTR S/ CAB	11209-JGRS	JG RETIF MTR S/ CAB
11209-JGSC	JG JTA MTR C/ CAB DE FIBRA	11209-JGRV	JG RETIF MTR C/ CAB DE FIBRA
11209-JGML	JG JTA MTR C/ CAB DE CHAPA	11209-JGRM	JG RETIF MTR C/ CAB DE CHAPA
11209-JGSAL	JG JTA MTR C/ CAB DE FIBRA (CRT ALÚMINIO)		
11209-JRSAL	JG JTA MTR C/ CAB DE FIBRA E C/ RET(CRT AL)		

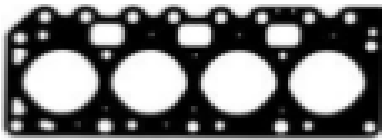

11202 SC - 1,6 MM - CIL. 75,5 MM

OPCIONAL

11202 SC-1M - 2,6 MM - CIL. 75,5 MM

11202 KT - 3.0 MM - CIL. 75.5 MM

JTA CABEÇOTE

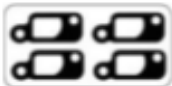

11137 PAK
JUNTA COLETOR
ESCAPE



11127 PAK
JTA ESCAPE



11167 PAK
JTA DO ESCAPE



11132 NA
JTA VALV.
TERMOSTÁTICA



11221 PAK
JTA COLETOR ADMISSÃO



11141 NA
JTA COLETOR ADMISSÃO



11208 KTBO - KIT VEDADORES MOTOR

JG JTA RETIFICAÇÃO



11129 NA
JTA DISTRIBUIÇÃO



11130 NA
JTA DISTRIBUIÇÃO TRAS.



11125 NA
JTA DA BOMBA DA AGUA



11146 NA
JTA BBA ÓLEO



261420
ANEL BUJÃO CARTER



11216 CB
JTA CARTER

11208-KP

KIT PARAFUSOS DO CABEÇOTE
11.00X1.50X120.00 (X10)

11208-KTRT

KIT DE RETENORES DO MOTOR

RET VALVULAS-07X11X10,5



1212919

RET. DIANT GIRABREQUIM - RET. GIRABREQUIM TRASEIRO

36,5X52,48X08

79X95,25X11,11



1135167



1135166

1.3/1.4 8V 4C - CORCEL / BELINA: I 71/77

MTR: RENAULT - GAS

11220-JGCB JG JTA MTR S/ CAB

11220-JGSC JG JTA MTR C/ CAB DE FIBRA

11220-JRSC JG JTA MTR C/ CAB DE FIBRA E C/ RET

11220-JGRS JG RETIF MTR S/ CAB

11220-JGRV JG RETIF MTR C/ CAB DE FIBRA

11220-JRRV JG RETIF MTR C/ CAB DE FIBRA E RET

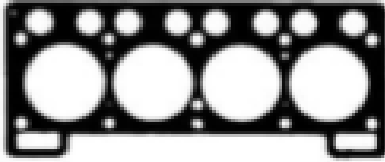

11601 SC - 1,4 MM - CIL. 77 MM

OPCIONAL

11601 KT - 2,4 MM - CIL. 77 MM

11601 TB - 1,9 MM - CIL. 77 MM

JTA CABEÇOTE



11621 PAK
JTA COLETOR ESCAPE

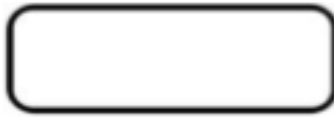

11226 BO
JTA TAMPA VÁLVULAS



11635 JGBO
BORRACHAS TAMPA VÁLVULAS

11226 KTBO
KIT JTA TAMPA VÁLVULAS



11231 NA
JTA SUP. BBA
D AGUA



11230 NA
JTA TPA
TRAS. CAB



10334 PAK
GAXETA ESCAPE



11237 PAK



11225 PP

JG JTA RETIFICAÇÃO



11272 NA
JTA BBA
COMBÚSTIVEL



11236 GV
JTA BBA
OLEO



11632 BO
JTA BOCAL
ÓLEO



11446 PAK
JTA ENTRE
COLETOR



11227 NA
JUNTA BOMBA
ÓLEO



11228 NA
JTA DISTRIBUIÇÃO



11229 NA
JUNTA BOMBA
AGUA



11232 FA
ANEL DO BUJÃO
CARTER
18X24X1,5



11219 CB
JUNTA CARTER

11807-KP

KIT PARAFUSOS DO CABEÇOTE
10.00X1.50X100.00 (X10)

11220-KTRT

KIT DE RETENORES DO MOTOR

RET. DIANT GIRABREQUIM - RET. GIRABREQUIM TRASEIRO

35X50X08

70X90X10



1112456



1111135

1.4/1.6 8V 4C - CORCEL / BELINA: II 78/83

MTR: GAS / ALC

11620-JGCB JG JTA MTR S/ CAB

11620-JGSC JG JTA MTR C/ CAB DE FIBRA

11620-JRSC JG JTA MTR C/ CAB DE FIBRA E C/ RET

11620-JGRS JG RETIF MTR S/ CAB

11620-JGRV JG RETIF MTR C/ CAB DE FIBRA

11620-JRRV JG RETIF MTR C/ CAB DE FIBRA E RET

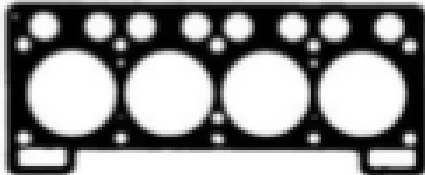

11601 SC - 1,4 MM - CIL. 77 MM

OPCIONAL

11601 KT - 2,4 MM - CIL. 77 MM

11601 TB - 1,9 MM - CIL. 77 MM

JTA CABEÇOTE



11230 NA
JTA TAMPA TRASEIRA
CABEÇOTE



11226 BO - JTA TAMPA VÁLVULAS



11635 JGBO
JG BORRACHAS TAMPA VÁLVULAS

11226 KTBO - KIT JTA TAMPA VÁLVULAS



11621 PAK
JTA COLETOR ESCAPE



OPCIONAL

11422 PAK
JTA COLETOR ESCAPE ALCOOL



11231 NA
JTA SUPERIOR
BBA D'AGUA



11237 PAK
JTA ESCAPE



11625 FL - CALÇOS CAMISA

JG JTA RETIFICAÇÃO



11272 NA
JTA BBA
COMBUSTIVEL



11236 GV
JTA BBA
OLEO



11632 BO
JTA BOCAL
ÓLEO



11446 PAK
JTA ENTRE
COLETOR



11636 GV
JTA BBA OLEO



11228 CB
JTA DA DISTRIBUIÇÃO



11229 NA
JUNTA DA BOMBA
DA AGUA



11227 NA
JTA BBA
ÓLEO



261420
ANEL BUJÃO
CARTER



11816 CB
JTA CARTER

11807-KP

KIT PARAFUSOS DO CABEÇOTE
10.00X1.50X100.00 (X10)

11620-KTRT

KIT DE RETENORES DO MOTOR

RET. DIANT GIRABREQUIM - RET. GIRABREQUIM TRASEIRO

35X50X08



1112456

82X105X12



1111945

1.4 16V 4C - FIESTA 9699 - COURIER : 97/99

MTR: ZETEC SE - GAS

11803-JGCB	JG JTA MTR S/ CAB	11803-JGRS	JG RETIF MTR S/ CAB
11803-JGSC	JG JTA MTR C/ CAB DE FIBRA	11803-JGRV	JG RETIF MTR C/ CAB DE FIBRA
11803-JGML	JG JTA MTR C/ CAB DE CHAPA	11803-JGRM	JG RETIF MTR C/ CAB DE CHAPA
11803-JRSC	JG JTA MTR C/ CAB DE FIBRA E C/ RET	11803-JRRV	JG RETIF MTR C/ CAB DE FIBRA E RET
11803-JRML	JG JTA MTR C/ CAB DE CHAPA E C/ RET	11803-JRRM	JG RETIF MTR C/ CAB DE CHAPA E RET

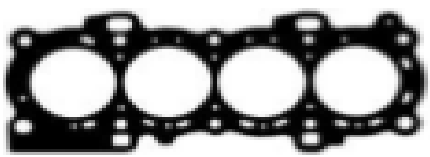

11401 SC - 1,4 MM - CIL. 78 MM
11401 MLS - 1,4 MM - CIL. 78 MM

OPCIONAL

11401 KT - 3,0 MM - CIL. 78 MM
11401-MLS-2M - 2,4 MM - CIL. 78 MM

JTA CABEÇOTE



11420 JGBO
JTA COLETOR ADMISSÃO

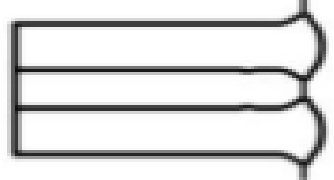

11826 BO
JTA TAMPA VÁLVULAS



11431 NA
JTA BBA D'AGUA



11521 F
JTA COLETOR ESCAPE



12538 BO
JTA
TERMOSTATO



11087 BO
JTA



12531 BO
JTA

11803 KTBO - KIT VEDADORES MOTOR

JG JTA RETIFICAÇÃO



261420
ANEL BUJÃO CARTER







11528 NA
JTA DISTRIBUIÇÃO E
BBA ÓLEO

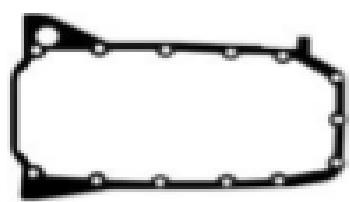

11529 NA
JTA BBA D'AGUA



11516 CB
JTA CARTER

<p>11803-KP KIT PARAFUSOS DO CABEÇOTE 10.00X1.50X143.00 (x10)</p>	<p>11803-KTRT OU 11803 KTRT-F (com ret flange tras.) KIT DE RETENORES DO MOTOR</p> <div style="display: flex; justify-content: space-around;"> <div style="text-align: center;"> <p>RET VALV-06X11X16,5</p>  <p>1230043 RETENTOR DIANT GIRABREQUIM 33X47X05</p>  <p>1130143</p> </div> <div style="text-align: center;"> <p>RET COMANDO-38X52X07</p>  <p>1130043 FLANGE TRASEIRO</p>  <p>11803 FR</p> </div> </div>
---	---

1.5 12V 3C - ECOSPORT 17/21 - KA 18/21 - FOCUS 19/21 - TERRITORY 20/21 (TURBO)

MTR: DRAGON FLEX TVICT / TURBO GAS

12508-JGCB	JG JTA MTR S/ CAB	12508-JGRS	JG RETIF MTR S/ CAB
12508-JGSC	JG JTA MTR C/ CAB DE FIBRA	12508-JGRV	JG RETIF MTR C/ CAB DE FIBRA
12508-JGML	JG JTA MTR C/ CAB DE CHAPA	12508-JGRM	JG RETIF MTR C/ CAB DE CHAPA
12508-JRSC	JG JTA MTR C/ CAB DE FIBRA E C/ RET	12508-JRRV	JG RETIF MTR C/ CAB DE FIBRA E RET
12508-JRML	JG JTA MTR C/ CAB DE CHAPA E C/ RET	12508-JRRM	JG RETIF MTR C/ CAB DE CHAPA E RET

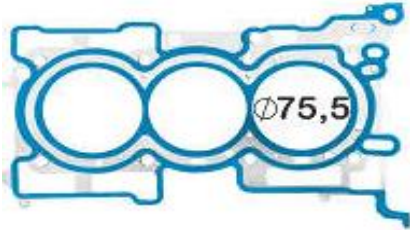

12503 MLS - 0,7 MM - CIL 75,5 MM
12503 SC - 1,20 MM - CIL 75,5 MM

JTA CABEÇOTE

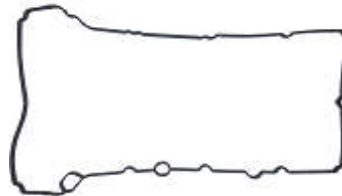

12528 BO
JTA TAMPA VÁLVULAS



12522 MLS
JUNTA COLETOR ESCAPE



12518 JGBO - JTA COLETOR ADMISSÃO

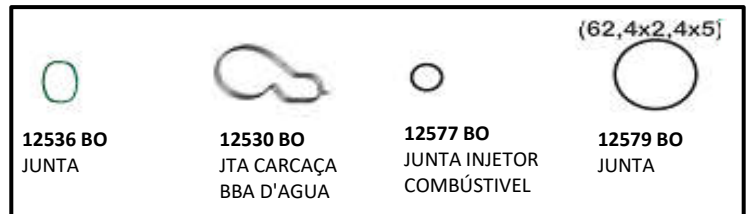

12508 KTBO - KIT VEDADORES MOTOR

JG JTA RETIFICAÇÃO

12508-KP
KIT PARAFUSOS DO CABEÇOTE
10.00X1.25X112.50(X8)

12508-KTRT OU 12508 KTRT-F (com ret flange tras.)
KIT DE RETENORES DO MOTOR
RET HASTE VALV-4,5X9,8X21,5



1230092

FLANGE TRASEIRO



12508 FR

RET DIANT GIRABREQUIM
32X45X06



1130192

1.5 16V 4C - KA / KA+ 14/18 - NEW FIESTA: 13/19

1.6 16V 4C - FOCUS 10/19 - NEW FIESTA 10/13 - ECOSPORT 12/17

MTR: SIGMA / HWDB / FLYA / SIGMA-TIVCT FLEX / SIGMA N-VCT FLEX

12506-JGCB	JG JTA MTR S/ CAB	12506-JGRS	JG RETIF MTR S/ CAB
12506-JGSC	JG JTA MTR C/ CAB DE FIBRA	12506-JGRV	JG RETIF MTR C/ CAB DE FIBRA
12506-JRSC	JG JTA MTR C/ CAB DE FIBRA E C/ RET	12506-JRRV	JG RETIF MTR C/ CAB DE FIBRA E RET
12506-JGML	JG JTA MTR C/ CAB DE CHAPA	12506-JGRM	JG RETIF MTR C/ CAB DE CHAPA
12506-JRML	JG JTA MTR C/ CAB DE CHAPA E C/ RET	12506-JRRM	JG RETIF MTR C/ CAB DE CHAPA E RET



12501 SC - 1,2 MM - CIL. 80 MM
12501 MLS - 0,5 MM - CIL. 80 MM

OPCIONAL

12501 KT - 2,2 MM - CIL. 80 MM

JTA CABEÇOTE



12520 JGBO
JTA COLETOR
ADMISSÃO



11431 NA
JTA TAMPA LATERAL
CABEÇOTE



12537 F
JTA CATALIZADOR

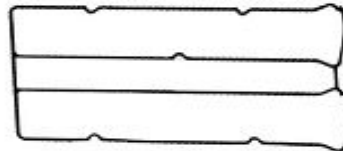

12526 BO
JTA TAMPA VÁLVULAS



12521 F
JTA COLETOR ESCAPE



11534 BO
JTA VENTILAÇÃO
DO CARTER



12578 BO
JTA CORPO
BORBOLETA



12531 BO
JTA VÁLVULA
TRMSTÁTICA



12532 BO
JTA CONEXÃO
BBA D AGUA

12506 KTBO - KIT BORRACHAS MOTOR

JG JTA RETIFICAÇÃO



11528 NA
JTA DISTRIBUIÇÃO



11529 NA
JTA BBA AGUA



46247 FA
ANEL BUJÃO CARTER

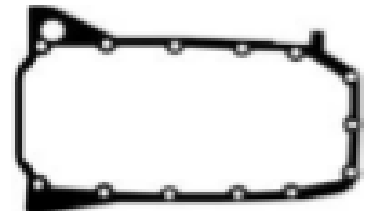

11516 CB
JTA CARTER

11803-KP
KIT PARAFUSOS DO CABEÇOTE
10.00X1.50X143.00 (X10)

11803-KTRT OU 11803 KTRT-F (com ret flange tras.)
KIT DE RETENORES DO MOTOR

RET VALV-06X11X16,5



1230043

RETENTOR DIANT GIRABREQUIM

33X47X05



1130143

RET COMANDO-38X52X07



1130043

FLANGE TRASEIRO



11803 FR

1.6 8V 4C-FORD- ESCORT / BELINA / DEL REY / PAMPA /SCALA / VERONA: 83/93

1.6 8V 4C-VW - GOL / PARATI / SAVEIRO / VOYAGE / LOGUS: 89/93

MTR: CHT / AE - GAS / ALC

11807-JGCB JG JTA MTR S/ CAB

11807-JGSC JG JTA MTR C/ CAB DE FIBRA

11807-JRSC JG JTA MTR C/ CAB DE FIBRA E C/ RET

11807-JGRS JG RETIF MTR S/ CAB

11807-JGRV JG RETIF MTR C/ CAB DE FIBRA

11807-JRRV JG RETIF MTR C/ CAB DE FIBRA E RET

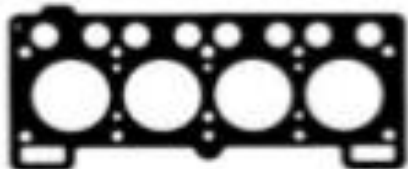

11802 SC - 1,4 MM - CIL. 78 MM

OPCIONAL

11802 KT - 2,4 MM - CIL. 78 MM

11802 TB - 1,9 MM - CIL. 78 MM

JTA CABEÇOTE



11226 BO - JTA TAMPA VÁLVULAS



11635 JGBO
JG BORRACHAS TAMPA VÁLVULAS

11226 KTBO - KIT JTA TAMPA VÁLVULAS



11821 PAK
JTA COLETOR ESCAPE



11822 PAK
JUNTA ESCAPE



46024 PAK
JTA ESCAPE



11625 FL
JTA CAMISA

JG JTA RETIFICAÇÃO



11655 NA
JTA BBA D'AGUA



11831 NA
JTA BBA DAGUA



11830 NA
JTA TRAS.
CABEÇOTE



11032 NA
JTA VÁLVULA
TERMOSTÁTICA



11030 PAK
JTA PEQUENA
ADMISSÃO



261420
ANEL BUJÃO CARTER



11272 NA
JTA BBA
COMBUSTIVEL



11636 GV
JTA BBA ÓLEO



11833 GV
JTA DISTRIBUIDOR



11632 CB
JTA BOCAL ÓLEO



11832 NA
JTA BBA AGUA



11228 PV
JTA DA DISTRIBUIÇÃO



11816 CB
JTA CARTER

11807-KP

KIT PARAFUSOS DO CABEÇOTE

10.00X1.50X100.00 (X10)

11806-KTRT

KIT DE RETENORES DO MOTOR

RET HASTE VÁLVULAS

(7x11x10,5)



1212919

RET. DIANT GIRABREQUIM - RET. GIRABREQUIM TRASEIRO

(35x50x8)



1112456

(82x105x12)



1111945

1.6 8V 4C - KA 01/14 - FIESTA 99/14 - ESCORT 00/02 - ECOSPORT 03/12 - FOCUS 01/09 - COURIER 99/13

MTR: ZETEC ROCAN - GAS / FLEX

11005-JGCB	JG JTA MTR S/ CAB	11005-JGRS	JG RETIF MTR S/ CAB
11005-JGSC	JG JTA MTR C/ CAB DE FIBRA	11005-JGRV	JG RETIF MTR C/ CAB DE FIBRA
11005-JGML	JG JTA MTR C/ CAB DE CHAPA	11005-JGRM	JG RETIF MTR C/ CAB DE CHAPA
11005-JRSC	JG JTA MTR C/ CAB DE FIBRA E C/ RET	11005-JRRV	JG RETIF MTR C/ CAB DE FIBRA E RET
11005-JRML	JG JTA MTR C/ CAB DE CHAPA E C/ RET	11005-JRRM	JG RETIF MTR C/ CAB DE CHAPA E RET



11001 SC - 1,2 MM - CIL. 70,5 MM
11001 MLS - 0,5 MM - CIL. 70,5 MM

OPCIONAL

11001 SC-2M - 2,0 MM - CIL. 70,5 MM
11001 KT - 3,0 MM - CIL. 70,5 MM
11001 MLS-1M - 1,0 MM - CIL. 70,5 MM
11001 MLS-2M - 1,2 MM - CIL. 70,5 MM
11001 MLS-3M - 1,5 MM - CIL. 70,5 MM

JTA CABEÇOTE



11123 OR
JTA COLETOR ESCAPE

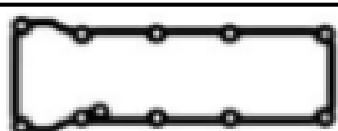

11626 BO



11047 BO
VEDADOR RESPIRO ÓLEO

11626 KTBO
KIT JTA TAMPA VALVULAS



11425 OR
JTA ESCAPE



11040 NA
JTA SUPORTE
BBA ÓLEO



11121 JGBO - JTA COLETOR ADMISSÃO

OPCIONAL



11092 BO
VEDADOR
VÁLVULA
DE DESVIO



11843 BO
JTA CARÇAÇA
TERMOSTATO



11087 BO
ANEL
TERMOSTATO



OR1-117
ANEL ORING
20,29 X 2,62

11004 KTBO 01 - KIT VEDADORES MOTOR

JG JTA RETIFICAÇÃO



11429 NA
JTA DISTRIBUIÇÃO E BBA
D'AGUA



11016 BP
JTA CARTER

11004-KP
KIT PARAFUSOS DO CABEÇOTE
11.00X1.50X158.00 (X10)
8.00X1.25X45.00(X2)

11004-KTRT 11004 KTRT-F (com ret flange tras.)
KIT DE RETENORES DO MOTOR
RET HASTE VALVULAS



(6x11x20)

1230045

RET. DIANT GIRABREQUIM - FLANGE TRASEIRO

40X62X7,5



1130045



11004 FR

1.6/1.8 8V 4C - VW - GOL / VOYAGE / PARATI / PASSAT / SANTANA / APOLO / SAVEIRO / LOGUS / POINTER: 85/95

1.6/1.8 8V 4C - FORD - ESCORT / BELINA / DEL REY / VERONA / VERSAILLES: 85/95

MTR: AP - GAS / ALC

46006-JGCB	JG JTA MTR S/ CAB	46006-JGRS	JG RETIF MTR S/ CAB
46006-JGSC	JG JTA MTR C/ CAB DE FIBRA	46006-JGRV	JG RETIF MTR C/ CAB DE FIBRA
46006-JGML	JG JTA MTR C/ CAB DE CHAPA	46006-JGRM	JG RETIF MTR C/ CAB DE CHAPA
46006-JRSC	JG JTA MTR C/ CAB DE FIBRA E C/ RET	46006-JRRV	JG RETIF MTR C/ CAB DE FIBRA E RET
46006-JRML	JG JTA MTR C/ CAB DE CHAPA E C/ RET	46006-JRRM	JG RETIF MTR C/ CAB DE CHAPA E RET



46001 SC - 2,0 MM - CIL. 83 MM
46002 MLS - 1,8 MM - CIL. 83,5 MM



46926 CB - JTA TAMPA VALVULAS

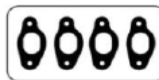

46721 PAK
JTA COLETOR
ESCAPE



46022 NA
JTA COL ETOR
ADMISSÃO

OPCIONAL

46002 MLS-2M - 2,8 MM - CIL. 83,5 MM
46001 KT - 3,0 MM - CIL. 83 MM

JTA CABEÇOTE



46024 PAK
JTA ESCAPE



46745 BO-VEDADOR
TERMOSTATO



46746 BO
VEDADOR TV



46747 BO
VEDADOR TV



OR1 -127-VEDADOR



46823 BO-VEDADOR
ADMISSÃO



OR1-139-VEDADOR



OR2-020
VEDADOR BBA D AGUA

464646 KTBO - JG VEDADORES MTR

JG JTA RETIFICAÇÃO



46729 NA
JTA FLANGE TRAS



46730 NA
JTA FLANGE DIANT



46734 NA 0,8
JTA BBA AGUA



46735 NA
JTA FILTRO OLEO



46032 NA
JTA BBA OLEO



46731 NA
JTA CANO D AGUA



46732 NA
JTA FLANGE CAB.



46937 NA
JTA BBA COMBUSTIVEL



46936 NA
JTA CANO D AGUA



46716 NA 0,8
JTA CARTER



46733 NA
JTA DISTRIBUIDOR



46759 NA
JTA BASE
CARBURADOR.



46725 GV
JTA BBA OLEO



46755 NA
JTA VALVULA
OLEO



46756 NA
ANEL CEBOLÃO

46006-KP

KIT PARAFUSOS DO CABEÇOTE

11.00X1.50X98.00 (X10)

46006-KTRT

KIT DE RETENORES DO MOTOR

RET HASTE VALVULAS

(8x11x10)



1212544

RET GIRABREQUIM DIANT

(32x47x10)



1111942

RET COMANDO

(32x47x10)



1111942

RET GIRABREQUIM TRAS.

(85x105x12)



1112283

1.6 16V 4C - NEW FIESTA 13/19 - ECOSPORT 15/17 - FOCUS 14/17 - KA/KA+: 17/19

MTR: ZETEC-S (16HDEZ) SIGMA - FLEX

12507-JGCB	JG JTA MTR S/ CAB	12507-JGRS	JG RETIF MTR S/ CAB
12507-JGSC	JG JTA MTR C/ CAB DE FIBRA	12507-JGRV	JG RETIF MTR C/ CAB DE FIBRA
12507-JGML	JG JTA MTR C/ CAB DE CHAPA	12507-JGRM	JG RETIF MTR C/ CAB DE CHAPA
12507-JRSC	JG JTA MTR C/ CAB DE FIBRA E C/ RET	12507-JRRV	JG RETIF MTR C/ CAB DE FIBRA E RET
12507-JRML	JG JTA MTR C/ CAB DE CHAPA E C/ RET	12507-JRRM	JG RETIF MTR C/ CAB DE CHAPA E RET



12501 SC - 1,2 MM - CIL. 80 MM
12501 MLS - 0,5 MM - CIL. 80 MM

OPCIONAL

12501 KT - 2,2 MM - CIL. 80 MM

JTA CABEÇOTE

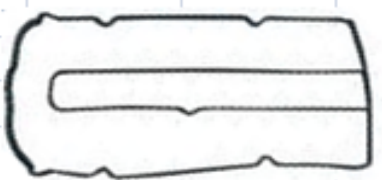

12525 BO
JTA TAMPA VÁLVULAS



12521 F
JTA COLETOR ESCAPE

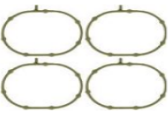

12520 JGBO
JTA COLETOR ADMISSÃO



11431 NA
JTA TAMPA LATERAL DO CABEÇOTE



12537 F
JTA CATALIZADOR



11534 BO
JTA VENTILAÇÃO DO CARTER



12578 BO
JTA CORPO BORBOLETA
Nº ORIG:



12531 BO
JTA VÁLVULA TRMOSTÁTICA
Nº ORIG:



12532 BO
JTA CONEXÃO BBA D AGUA

12506 KTBO - KIT BORRACHAS MOTOR

JG JTA RETIFICAÇÃO

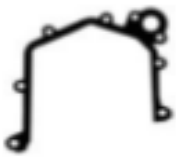

11528 NA
JTA DISTRIBUIÇÃO



11529 NA
JTA BBA AGUA



46247 FA
ANEL BUJÃO CARTER

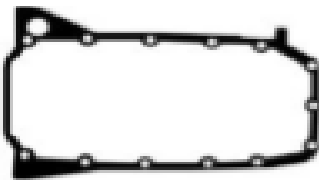

11516 CB
JTA CARTER

11803-KP

KIT PARAFUSOS DO CABEÇOTE

10.00X1.50X143.00 (X10)

12507-KTRT

KIT DE RETENORES DO MOTOR

RET VALV-06X11X16,5



1230043

RETENTOR DIANT GIRABREQUIM

33X47X05



1130143

12507 KTRT-F (com ret flange tras.)

KIT DE RETENORES DO MOTOR

RET COMANDO-45X56,4X07



1130084

FLANGE TRASEIRO



11803 FR

1.6/1.8 8V 4C FORD - ESCORT 94/96 - PAMPA 93/97 - ROYALE / VERONA / VERSAILLES: 94/96

1.6/1.8 8V 4C VW - GOL / SANTANA / SAVEIRO / PARATI / PASSAT / GOLF / APOLLO / LOGUS / POINTER: 95/
MTR: AP INJEÇÃO MI - AP UDB GASOLINA - ALC / GAS / TOTAL FLEX

46808-JGCB	JG JTA MTR S/ CAB	46808-JGRS	JG RETIF MTR S/ CAB
46808-JGSC	JG JTA MTR C/ CAB DE FIBRA	46808-JGRV	JG RETIF MTR C/ CAB DE FIBRA
46808-JGML	JG JTA MTR C/ CAB DE CHAPA	46808-JGRM	JG RETIF MTR C/ CAB DE CHAPA
46808-JRSC	JG JTA MTR C/ CAB DE FIBRA E C/ RET	46808-JRRV	JG RETIF MTR C/ CAB DE FIBRA E RET
46808-JRML	JG JTA MTR C/ CAB DE CHAPA E C/ RET	46808-JRRM	JG RETIF MTR C/ CAB DE CHAPA E RET

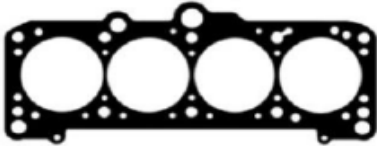

46001 SC - 1,8 MM - CIL. 83 MM
46002 MLS - 1,8 MM - CIL. 83MM

OPCIONAL

46001 KT - 2,8 MM - CIL. 83 MM
46002 MLS-2M - 2,8 MM - CIL. 83 MM

JTA CABEÇOTE

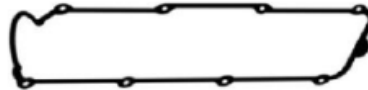

46740 BO
JTA TAMPÁ VÁLVULAS

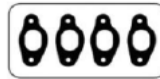

46721 PAK
JTA COLETOR ESCAPE



46728 NA
JTA COL ADMISSÃO



46723 PAK
JTA ESCAPE



46322 F
JTA ESCAPE



46745 BO
ANEL BBA D AGUA E
VALV. TERMOSTÁTICATO



OR2-020
ANEL BBA COMBUSTIVEL



OR1 -127
VEDADOR



OR1-139
VEDADOR

46507 KTBO - JG VEDADORES MOTOR

JG JTA RETIFICAÇÃO



46729 NA
JTA FLANGE TRAS



46730 NA
JTA FLANGE DIANT

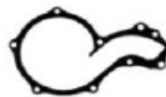

46734 NA 0,8
JTA BBA AGUA



46735 NA
JTA FILTRO OLEO



46731 NA
JTA CANO D AGUA



46732 NA
JTA FLANGE CAB.



46937 NA
JTA BBA
COMBUSTIVEL



46032 NA
JTA BBA OLEO



46936 NA
JTA CANO D AGUA



46716 NA 0,8
JUNTA CARTER



46733 NA
JTA DISTRIBUIDOR



46759 NA
JTA BASE
CARBURADOR.



261420
ARRUELA BUJAO
CARTER



46755 NA
JTA VALVULA
OLEO



46756 NA
ANEL CEBOLÃO



161014
ARR COBRE
10X14X1,5



46725 GV
JTA BBA OLEO

46808-KP

KIT PARAFUSOS DO CABEÇOTE
11.00X1.50X106.00 (X10)

46006-KTRT ou 46006 KTRT-F (com ret flange tras.)

KIT DE RETENORES DO MOTOR

RET HASTE VALVULAS

(8x11x10)



1212544

RET COMANDO

(32x47x10)



1111942

RET GIRAB. DIANT

(32x47x10)^l



1111942

RET GIRAB TRAS. FLANGE TRAS.

(85x105x12)



1112283



46808 FR

1.8 16V 4C - ESCORT 96/02 - MONDEO 93/97
MTR: ZETEC (DOHC) - GAS

11706-JGCB	JG JTA MTR S/ CAB	11706-JGRS	JG RETIF MTR S/ CAB
11706-JGSC	JG JTA MTR C/ CAB DE FIBRA	11706-JGRV	JG RETIF MTR C/ CAB DE FIBRA
11706-JGML	JG JTA MTR C/ CAB DE CHAPA	11706-JGRM	JG RETIF MTR C/ CAB DE CHAPA
11706-JRSC	JG JTA MTR C/ CAB DE FIBRA E C/ RET	11706-JRRV	JG RETIF MTR C/ CAB DE FIBRA E RET
11706-JRML	JG JTA MTR C/ CAB DE CHAPA E C/ RET	11706-JRRM	JG RETIF MTR C/ CAB DE CHAPA E RET

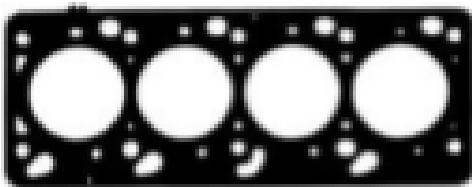

11101 SC - 2,0 MM - CIL. 83 MM
 11101 MLS - 1,9 MM - CIL. 83 MM

OPCIONAL

11101 KT - 3,0 MM - CIL. 83 MM
 11101 MLS-2M - 2,9 MM - CIL. 83 MM

JTA CABEÇOTE

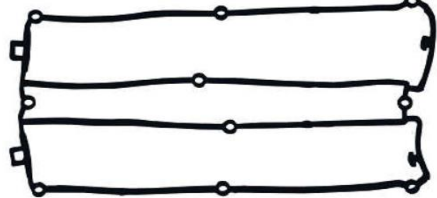

11526 BO - JTA TAMPÁ VÁLVULA



11026 JGBO-JG BORR PARAFUSOS TV
 TAMPÁ VÁLVULA

11526 KTBO - KIT JUNTAS TAMPÁ VÁLVULAS



11331 PAK
 JTA COLETOR ESCAPE



11320 JGBO
 JTA COLETOR ADMISSÃO

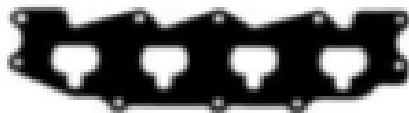

11441 PAK
 BAQUELITE COLETOR ADMISSÃO

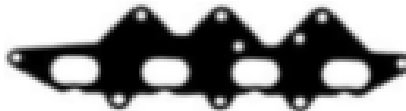

11451 NA
 JTA COLETOR ADMISSÃO



11044 NA
 JTA BBA D AGUA



11045 NA
 JTA TERMOSTATO

JG JTA RETIFICAÇÃO



11039 NA
 JTA BBA ÓLEO



11038 NA
 JTA MANCAL TRASEIRO



261622
 ANEL BUJÃO CARTER
 16,2 X 22 X 1,5 MM



11046 NA
 JTA BBA ÓLEO



11048 NA
 JTA TUBO SEPARAÇÃO
 ÓLEO CARTER

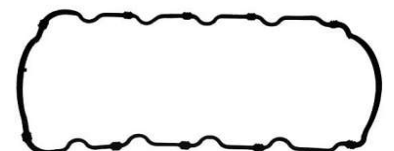

11916 BO
 JTA CARTER

11706-KP

KIT PARAFUSOS DO CABEÇOTE
 10.00X1.50X102.00 (X10)

11706-KTRT

KIT DE RETENORES DO MOTOR

RET VALV-06X12X19,5



1230049

RETENTOR DIANT GIRABREQUIM

35X50X08



1112456

RET COMANDO-42X53X07



1130149

FLANGE TRASEIRO

88X108X10



1130249

1.8 16V 4C - FOCUS / MONDEO: 00/05

MTR: ZETEC-E (DOHC) - GAS / FLEX

11108-JGCB	JG JTA MTR S/ CAB	11108-JGRS	JG RETIF MTR S/ CAB
11108-JGSC	JG JTA MTR C/ CAB DE FIBRA	11108-JGRV	JG RETIF MTR C/ CAB DE FIBRA
11108-JGML	JG JTA MTR C/ CAB DE CHAPA	11108-JGRM	JG RETIF MTR C/ CAB DE CHAPA
11108-JRSC	JG JTA MTR C/ CAB DE FIBRA E C/ RET	11108-JRRV	JG RETIF MTR C/ CAB DE FIBRA E RET
11108-JRML	JG JTA MTR C/ CAB DE CHAPA E C/ RET	11108-JRRM	JG RETIF MTR C/ CAB DE CHAPA E RET

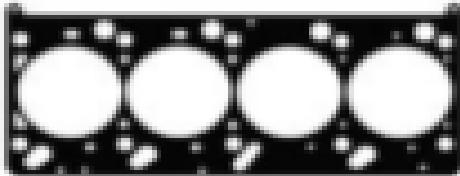

11101 SC - 1,2 MM - CIL. 83 MM
11101 MLS - 1,0 MM - CIL. 83 MM

OPCIONAL

11101 KT - 3,0 MM - CIL. 83 MM
11101 MLS-2M - 2,9 MM - CIL. 83 MM

JTA CABEÇOTE



11520 JGBO
JTA COLETOR ADMISSÃO

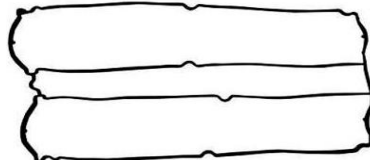

11525 BO
JTA TAMPA VÁLVULAS



11522 PAK
JTA COLETOR ESCAPE



11044 NA
JTA BBA D AGUA



11048 NA
JTA TUBO SEPARAÇÃO ÓLEO CARTER

JG JTA RETIFICAÇÃO



11045 NA
JTA TERMOSTATO



11046 NA
JTA BBA ÓLEO



261620
ANEL BUJÃO CARTER
16,2 X 19 X 1,5 MM



OR1-225
ANEL ORING
47,22 X 3,53 MM



OR1-210
ANEL ORING
19 X 3,53 MM



11038 NA
JTA MANCAL TRASEIRO



11041 NA
JTA BBA ÓLEO



11517 NA
JTA SUB CARTER



11117 BA
JTA CARTER

11706-KP

KIT PARAFUSOS DO CABEÇOTE
10.00X1.50X102.00 (X10)

11706-KTRT

KIT DE RETENORES DO MOTOR

RET VALV-06X12X19,5



1230049

RETENTOR DIANT GIRABREQUIM

35X50X08



1112456

RET COMANDO-42X53X07



1130149

FLANGE TRASEIRO

88X108X10



1130249

2.0 8V 4C - VW - GOL / VOYAGE / PARATI / PASSAT / SANTANA / APOLO / SAVEIRO / LOGUS / POINTER: 85/95

2.0 8V 4C - FORD - ESCORT / BELINA / DEL REY / VERONA / VERSAILLES: 85/95

MTR: AP - GAS / ALC

46007-JGCB	JG JTA MTR S/ CAB	46007-JGRS	JG RETIF MTR S/ CAB
46007-JGSC	JG JTA MTR C/ CAB DE FIBRA	46007-JGRV	JG RETIF MTR C/ CAB DE FIBRA
46007-JGML	JG JTA MTR C/ CAB DE CHAPA	46007-JGRM	JG RETIF MTR C/ CAB DE CHAPA
46007-JRSC	JG JTA MTR C/ CAB DE FIBRA E C/ RET	46007-JRRV	JG RETIF MTR C/ CAB DE FIBRA E RET
46007-JRML	JG JTA MTR C/ CAB DE CHAPA E C/ RET	46007-JRRM	JG RETIF MTR C/ CAB DE CHAPA E RET



46002 SC - 2,0 MM - CIL. 83,5 MM
46002 MLS - 1,8 MM - CIL. 83,5 MM

OPCIONAL

46002 MLS-2M - 2,3 MM - CIL. 83,5 MM
46002 MLS-3M - 2,8 MM - CIL. 83,5 MM
46002 KT - 3,0 MM - CIL. 83,5 MM

JTA CABEÇOTE



46024 PAK
JTA ESCAPE



46926 CB
JTA TAMPA VALVULAS

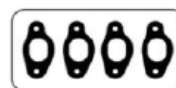

46721 PAK
JTA COLETOR ESCAPE



46022 NA
JTA COLETOR ADMISSÃO

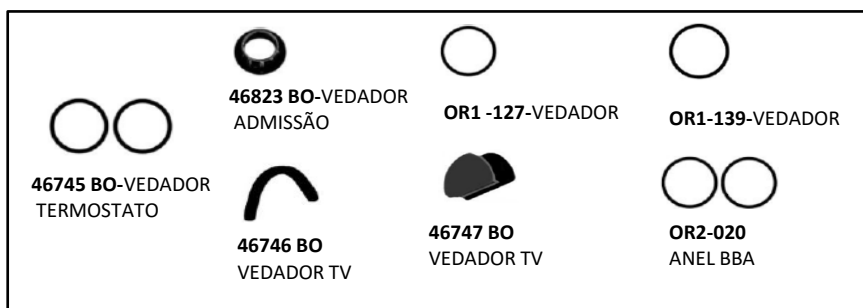

464646 KTBO - JG VEDADORES MTR

JG JTA RETIFICAÇÃO



46729 NA
JTA FLANGE TRAS.



46730 NA
JTA FLANGE DIANT.



46734 NA 0,8
JTA BBA AGUA



46032 NA
JTA BBA OLEO



46735 NA
JTA FILTRO



46725 NA
JTA BBA



46759 NA
ITA BASE CARBURADOR



46731 NA
JTA CANO



46937 NA
JTA BBA COMBUSTIVEL



46936 NA
JTA CANO D AGUA.



46732 NA
JTA FLANGE CABEÇOTE



46733 NA
ANEL DISTRIBUIDOR



46755 NA
ANEL VLV



46756 NA
ANEL

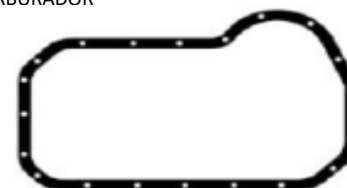

46716 NA 0,8
JTA CARTER

46006-KP

KIT PARAFUSOS DO CABEÇOTE
11.00X1.50X98.00 (X10)

46006-KTRT

KIT DE RETENORES DO MOTOR

RET HASTE VALVULAS

(8x11x10)



1212544

RET GIRABREQUIM DIANT

(32x47x10)



1111942

RET COMANDO

(32x47x10)



1111942

RET GIRABREQUIM TRAS.

(85x105x12)



1112283

2.0 16V 4C - MONDEO 93/00

MTR: ZETEC (DOHC) / ZETEC-E-NGA GAS

11707-JGCB	JG JTA MTR S/ CAB	11707-JGRS	JG RETIF MTR S/ CAB
11707-JGSC	JG JTA MTR C/ CAB DE FIBRA	11707-JGRV	JG RETIF MTR C/ CAB DE FIBRA
11707-JGML	JG JTA MTR C/ CAB DE CHAPA	11707-JGRM	JG RETIF MTR C/ CAB DE CHAPA
11707-JRSC	JG JTA MTR C/ CAB DE FIBRA E C/ RET	11707-JRRV	JG RETIF MTR C/ CAB DE FIBRA E RET
11707-JRML	JG JTA MTR C/ CAB DE CHAPA E C/ RET	11707-JRRM	JG RETIF MTR C/ CAB DE CHAPA E RET

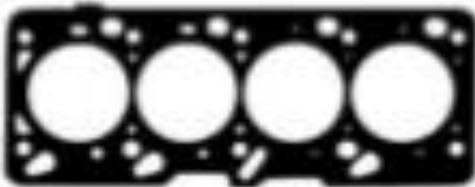

11102 SC - 2,0 MM - CIL. 86 MM
 11102 MLS - 1,9 MM - CIL. 86 MM

OPCIONAL

11102 KT - 3,0 MM - CIL. 86 MM
 11102 MLS-2M - 2,9 MM - CIL. 86 MM

JTA CABEÇOTE

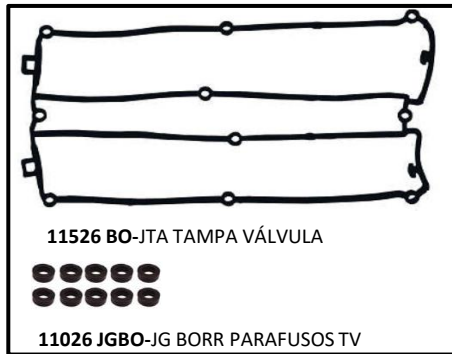

11526 KTBO - KIT JUNTAS TAMPÁ VÁLVULAS



11331 PAK
 JTA COLETOR ESCAPE



11320 JGBO
 JTA COLETOR ADMISSÃO

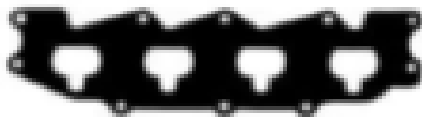

11441 PAK
 BAQUELITE COLETOR ADMISSÃO



11044 NA
 JTA BBA D AGUA



11045 NA
 JTA TERMOSTATO



11451 NA
 JTA COLETOR ADMISSÃO

JG JTA RETIFICAÇÃO



11039 NA
 JTA BBA ÓLEO



11038 NA
 JTA MANCAL TRASEIRO



261622
 ANEL BUJÃO CARTER
 16,2 X 22 X 1,5 MM



11046 NA
 JTA BBA ÓLEO



11048 NA
 JTA TUBO
 SEPARAÇÃO
 ÓLEO CARTER

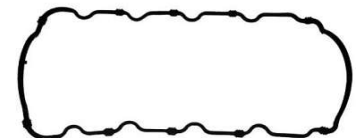

11916 BO
 JTA CARTER

11706-KP

KIT PARAFUSOS DO CABEÇOTE
 10.00X1.50X102.00 (X10)

11706-KTRT

KIT DE RETENORES DO MOTOR

RET VALV-06X12X19,5



1230049

RETENTOR DIANT GIRABREQUIM

35X50X08



1112456

RET COMANDO-42X53X07



1130149

FLANGE TRASEIRO

88X108X10



1130249

2.0 16V 4C - FOCUS / MONDEO: 00/05

MTR: ZETEC-E (DOHC) - GAS

11109-JGCB	JG JTA MTR S/ CAB	11109-JGRS	JG RETIF MTR S/ CAB
11109-JGSC	JG JTA MTR C/ CAB DE FIBRA	11109-JGRV	JG RETIF MTR C/ CAB DE FIBRA
11109-JGML	JG JTA MTR C/ CAB DE CHAPA	11109-JGRM	JG RETIF MTR C/ CAB DE CHAPA
11109-JRSC	JG JTA MTR C/ CAB DE FIBRA E C/ RET	11109-JRRV	JG RETIF MTR C/ CAB DE FIBRA E RET
11109-JRML	JG JTA MTR C/ CAB DE CHAPA E C/ RET	11109-JRRM	JG RETIF MTR C/ CAB DE CHAPA E RET

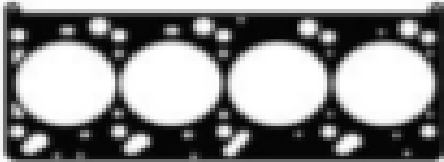

11102 SC - 2,0 MM - CIL. 86 MM
11102 MLS - 1,9 MM - CIL. 86 MM

OPCIONAL

11102 KT - 3,0 MM - CIL. 86 MM
11102 MLS-2M - 2,9 MM - CIL. 86 MM

JTA CABEÇOTE



11520 JGBO - JTA COLETOR ADMISSÃO

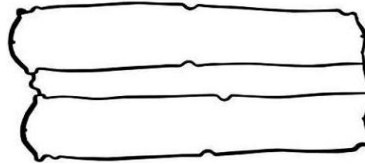

11525 BO
JTA TAMPAS VÁLVULAS



11522 PAK
JTA COLETOR ESCAPE



11044 NA
JTA BBA D'ÁGUA



11048 NA
JTA TUBO SEPARAÇÃO ÓLEO CARTER

JG JTA RETIFICAÇÃO



11045 NA
JTA TERMOSTATO



11046 NA
JTA BBA ÓLEO



261620
ANEL BUJÃO CARTER
16,2 X 19 X 1,5 MM



OR1-225
ANEL ORING
47,22 X 3,53 MM



OR1-210
ANEL ORING
19 X 3,53 MM



11038 NA
JTA MANCAL TRASEIRO



11041 NA
JTA BBA ÓLEO



11517 NA
JTA SUB CARTER



11117 BA
JTA CARTER

11706-KP

KIT PARAFUSOS DO CABEÇOTE
10.00X1.50X102.00 (X10)

11706-KTRT

KIT DE RETENORES DO MOTOR

RET VALV-06X12X19,5



1230049

RETENTOR DIANT GIRABREQUIM

35X50X08



1112456

RET COMANDO-42X53X07



1130149

FLANGE TRASEIRO

88X108X10



1130249

2.0 16V 4C - FOCUS 05/10

MTR: ECOBOOST / MGDA / XQDA / DURATEC HE-AODA - GAS

12206-JGCB	JG JTA MTR S/ CAB	12206-JGRS	JG RETIF MTR S/ CAB
12206-JGSC	JG JTA MTR C/ CAB DE FIBRA	12206-JGRV	JG RETIF MTR C/ CAB DE FIBRA
12206-JGML	JG JTA MTR C/ CAB DE CHAPA	12206-JGRM	JG RETIF MTR C/ CAB DE CHAPA
12206-JRSC	JG JTA MTR C/ CAB DE FIBRA E C/ RET	12206-JRRV	JG RETIF MTR C/ CAB DE FIBRA E RET
12206-JRML	JG JTA MTR C/ CAB DE CHAPA E C/ RET	12206-JRRM	JG RETIF MTR C/ CAB DE CHAPA E RET



12202 MLS - 0,5 MM - CIL. 88 MM
 12202 SC - 1,2 MM - CIL. 88 MM

OPCIONAL

12202 MLS-3M - 2,0 MM - CIL. 88 MM
 12202 KT - 2,2 MM - CIL. 88 MM

JUNTA DO CABEÇOTE



12222 F
 JUNTA DO ESCAPE



12227 KTBO
 JUNTA DA TAMPA DE VALVULAS



12224 MLS
 JUNTA DO COLETOR DE ESCAPE



12219 JGBO
 JUNTA DO COLETOR DE ADMISSÃO



OR1-230
 JUNTA BBA D'AGUA



12243 BO
 JUNTA FILTRO OLEO



OR1-128
 JUNTA BBA D'AGUA



12244 BO
 JUNTA VALVULA TERMOSTATICA



12232 BO
 JUNTA BBA COMBÚSTIVEL



12230 BO
 JTA SEPARADOR VAPOR OLEO

12210 KTBO - KIT DE BORRACHAS DO MOTOR

JG JTA RETIFICAÇÃO



11153 NA
 JUNTA SUPORTE FILTRO OLEO

12207-KP
 KIT PARAFUSOS DO CABEÇOTE
 10.00X1.25X145.00(X10)

12207-KTRT OU 12207-KTRT-F
 KIT DE RETENORES DO MOTOR
 RET VALV-5,5X11X18,5



1230073

RET DIANT GIRABREQUIM
 37X50X08



1130073

FLANGE TRASEIRA



12207 FR

2.0 16V 4C - ECOSPORT 03/21 - FOCUS 13/19 - MONDEO 00/07

MTR: DURATEC-HE CJBA (TPA.VALV.PLASTICO) - GAS / FLEX

12207-JGCB	JG JTA MTR S/ CAB	12207-JGRS	JG RETIF MTR S/ CAB
12207-JGSC	JG JTA MTR C/ CAB DE FIBRA	12207-JGRV	JG RETIF MTR C/ CAB DE FIBRA
12207-JGML	JG JTA MTR C/ CAB DE CHAPA	12207-JGRM	JG RETIF MTR C/ CAB DE CHAPA
12207-JRSC	JG JTA MTR C/ CAB DE FIBRA E C/ RET	12207-JRRV	JG RETIF MTR C/ CAB DE FIBRA E RET
12207-JRML	JG JTA MTR C/ CAB DE CHAPA E C/ RET	12207-JRRM	JG RETIF MTR C/ CAB DE CHAPA E RET



12201 SC - 1,2 MM - CIL. 88 MM
12201 MLS - 0,5 MM - CIL. 88 MM

OPCIONAL

12201 KT - 2,2 MM - CIL. 88 MM
12201 MLS-1M - 1,5 MM - CIL. 88 MM
12201 MLS-3M - 2,0 MM - CIL. 88 MM

JTA CABEÇOTE

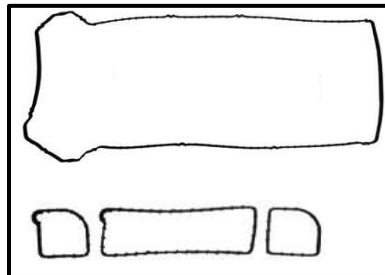

11527 KTBO
KIT JUNTAS TAMPA VÁLVULAS



12221 F
JTA COLETOR ESCAPE



12220 JGBO
JTA COLETOR ADMISSÃO



12285 BO
VEDADOR ARANHA /
CAIXA BORBOLETA



12222 F
ITA ESCAPE



12233 BO
JUNTA DO

OPCIONAL

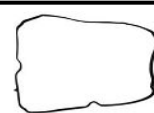

12230 BO
JTA TPA RESPIRO



12284 BO
JTA INJEÇÃO



12232 BO
JTA
TERMOSTATO



11155 NA
JTA CONEXÃO SAÍDA
D AGUA



11158 NA
JTA VÁLVULA REGULADORA
VENTILAÇÃO MOTOR

12207 KTBO - JG VEDADORES MOTOR

JG JTA RETIFICAÇÃO



OR1-225
ANEL ORING
47,22 X 3,53 MM

OPCIONAL



OR1-210
ANEL ORING
19 X 3,53 MM



12247 BO
ANEL DO BUJÃO
DO CARTER



11153 NA
JTA SUPORTE FILTRO ÓLEO



11154 NA
JTA

12207-KP
KIT PARAFUSOS DO CABEÇOTE
10.00X1.25X145.00(X10)

12207-KTRT OU 12207 KTRT-F (com ret flange tras.)
KIT DE RETENORES DO MOTOR
RET VALV-5,5X11X18,5



1230073

RETENOR DIANT GIRABREQUIM

37X50X08



1130073

FLANGE TRASEIRO



12207 FR

2.0 16V 4C - FUSION 12/15
MTR: ECOBOOST GAS

12806-JGCB	JG JTA MTR S/ CAB	12806-JGRS	JG RETIF MTR S/ CAB
12806-JGSC	JG JTA MTR C/ CAB DE FIBRA	12806-JGRV	JG RETIF MTR C/ CAB DE FIBRA
12806-JGML	JG JTA MTR C/ CAB DE CHAPA	12806-JGRM	JG RETIF MTR C/ CAB DE CHAPA
12806-JRSC	JG JTA MTR C/ CAB DE FIBRA E C/ RET	12806-JRRV	JG RETIF MTR C/ CAB DE FIBRA E RET
12806-JRML	JG JTA MTR C/ CAB DE CHAPA E C/ RET	12806-JRRM	JG RETIF MTR C/ CAB DE CHAPA E RET



12202 MLS - 0,5 MM - CIL. 88 MM
12202 SC - 1,2 MM - CIL. 88 MM

OPCIONAL

12202 MLS-3M - 2,0 MM - CIL. 88 MM
12202 KT - 2,2 MM - CIL. 88 MM

JUNTA CABEÇOTE

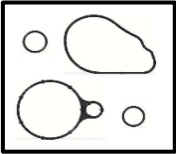

12243 KTBO
 KIT VEDADORES BOMBA VÁCUO



12226 KTBO
 JUNTA TAMPA VALVULAS



12821 MLS
 JUNTA COLETOR ESCAPE



12222 F
 JUNTA ESCAPE



12219 JGBO
 JUNTA COLETOR ADMISSÃO







OR1-230
 VJUNTA BBA D'AGUA



12243 BO
 JUNTA FILTRO OLEO



OR1-128
 JUNTA BBA D'AGUA



12244 BO
 JUNTA VALVULA TERMOSTATICA



12232 BO
 JUNTA BBA COMBÚSTIVEL





47433 BO
 JTA SEPARADOR VAPOR OLEO

12210 KTBO - KIT BORRACHAS MOTOR

JG JTA RETIFICAÇÃO



11153 NA
 JUNTA SUPORTE FILTRO OLEO

<p>12207-KP KIT PARAFUSOS DO CABEÇOTE 10.00X1.25X145.00(X10)</p>	<p>12207-KTRT OU 12207-KTRT-F KIT DE RETENORES DO MOTOR</p> <p>RET VALV-5,5X11X18,5</p>  <p>1230073</p>
<p>RET DIANT GIRABREQUIM 37X50X08</p>  <p>1130073</p>	<p>FLANGE TRASEIRA</p>  <p>12207 FR</p>

2.0 16V 4C - FUSION 16/20 - FUSION HÍBRID 14/20 - MAVERICK 21/22 - BRONCO 21/22

MTR: ECOBOOST GAS (ASP/TURBO) - ECOBOOST/ATKINSON - GASOLINA/ELETRICO

12807-JGCB	JG JTA MTR S/ CAB	12807-JGRS	JG RETIF MTR S/ CAB
12807-JGSC	JG JTA MTR C/ CAB DE FIBRA	12807-JGRV	JG RETIF MTR C/ CAB DE FIBRA
12807-JGML	JG JTA MTR C/ CAB DE CHAPA	12807-JGRM	JG RETIF MTR C/ CAB DE CHAPA
12807-JRSC	JG JTA MTR C/ CAB DE FIBRA E C/ RET	12807-JRRV	JG RETIF MTR C/ CAB DE FIBRA E RET
12807-JRML	JG JTA MTR C/ CAB DE CHAPA E C/ RET	12807-JRRM	JG RETIF MTR C/ CAB DE CHAPA E RET



12801 MLS - 1,0 MM - CIL. 89 MM
12801-SC - 1,2 MM - CIL. 89 MM

OPCIONAL

12801 MLS-1M - 1,5 MM - CIL. 89 MM
12801 MLS-2M - 2,0 MM - CIL. 89 MM
12801 KT - 2,2 MM - CIL. 89 MM

JUNTA CABEÇOTE

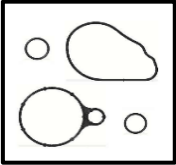

12243 KTBO
KIT VEDADORES BOMBA VÁCUO



12226 KTBO
JUNTA TAMPA VALVULAS



12824 MLS
JUNTA COLETOR ESCAPE



12222 F
JUNTA ESCAPE



12219 JGBO
JUNTA COLETOR ADMISSÃO



OR1-230
VJUNTA
BBA
D'AGUA



12243 BO
JUNTA
FILTRO
OLEO



OR1-128
JUNTA BBA
D'AGUA



12244 BO
JUNTA VALVULA
TERMOSTATICA



12232 BO
JUNTA BBA
COMBÚSTI-
VEL





47433 BO
JTA SEPARADOR
VAPOR OLEO

12210 KTBO - KIT BORRACHAS MOTOR

JG JTA RETIFICAÇÃO



11153 NA
JUNTA SUPORTE FILTRO OLEO

<p>12207-KP KIT PARAFUSOS DO CABEÇOTE 10.00X1.25X145.00(X10)</p>	<p>12207-KTRT OU 12207-KTRT-F KIT DE RETENORES DO MOTOR</p> <p>RET VALV-5,5X11X18,5</p>  <p>1230073</p>
<p>RET DIANT GIRABREQUIM 37X50X08</p>  <p>1130073</p>	<p>FLANGE TRASEIRA</p>  <p>12207 FR</p>

2.0/2.3 16V 4C - MONDEO 02/05 - ECOSPORT 08/19 - FOCUS 10/13 - RANGER 01/09 (2.3 16V)

MTR: DURATECH HE - GAS / FLEX - (TPA VAL. DE ALUMINIO)

12209-JGCB	JG JTA MTR S/ CAB	12209-JGRS	JG RETIF MTR S/ CAB
12209-JGSC	JG JTA MTR C/ CAB DE FIBRA	12209-JGRV	JG RETIF MTR C/ CAB DE FIBRA
12209-JGML	JG JTA MTR C/ CAB DE CHAPA	12209-JGRM	JG RETIF MTR C/ CAB DE CHAPA
12209-JRSC	JG JTA MTR C/ CAB DE FIBRA E C/ RET	12209-JRRV	JG RETIF MTR C/ CAB DE FIBRA E RET
12209-JRML	JG JTA MTR C/ CAB DE CHAPA E C/ RET	12209-JRRM	JG RETIF MTR C/ CAB DE CHAPA E RET



12202 SC - 1,2 MM - CIL. 88 MM
12202 MLS - 0,5 MM - CIL. 88 MM

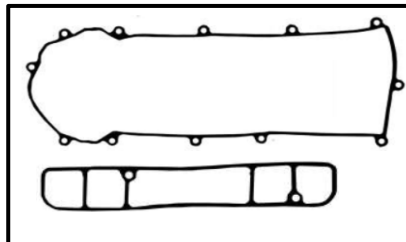

11523 KTBO
KIT DE JUNTAS TAMPA VÁLVULAS



12221 F
JTA COLETOR ESCAPE



12220 JGBO
JTA COLETOR ADMISSÃO

OPCIONAL
12202 KT - 2,2 MM - CIL. 88 MM
12202 MLS-3M - 2,0 MM - CIL. 88 MM

JTA CABEÇOTE

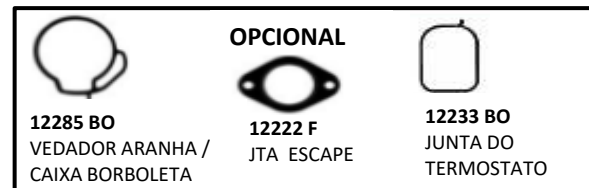

12285 BO
VEDADOR ARANHA /
CAIXA BORBOLETA

OPCIONAL

12222 F
JTA ESCAPE



12233 BO
JUNTA DO
TERMOSTATO



11155 NA
JTA CONEXÃO SAÍDA D AGUA



11158 NA
JTA VÁLVULA REGULADORA
VENTILAÇÃO MOTOR

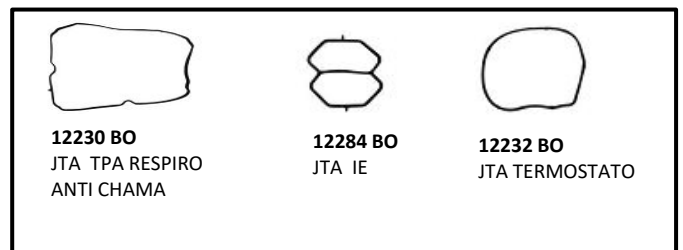

12230 BO
JTA TPA RESPIRO
ANTI CHAMA

12284 BO
JTA IE

12232 BO
JTA TERMOSTATO

12207 KTBO - KIT VEDADORES MOTOR

JG JTA RETIFICAÇÃO



OR1-225
ANEL ORING
47,22 X 3,53 MM

OPCIONAL

OR1-210
ANEL ORING
19 X 3,53 MM



12247 BO
ANEL DO BUJÃO
DO CARTER



11153 NA
JTA SUPORTE FILTRO ÓLEO



11154 NA
JTA

12207-KP
KIT PARAFUSOS DO CABEÇOTE
10.00X1.25X145.00(X10)

12207-KTRT OU 12207 KTRT-F (com ret flange tras.)
KIT DE RETENORES DO MOTOR
RET VALV-5,5X11X18,5



1230073

RETENTOR DIANT GIRABREQUIM

FLANGE TRASEIRO

37X50X08



1130073



12207 FR

2.2 8V 4C - WILLYS JEEP 48 /53

MTR: MILITAR (CONTINENTAL) - GAS

13006-JGCB JG JTA MTR S/ CAB

13006-JGSC JG JTA MTR C/ CAB DE FIBRA

13006-JGRS JG RETIF MTR S/ CAB

13006-JGRV JG RETIF MTR C/ CAB DE FIBRA



13001 SC
JTA CABEÇOTE



13130 CB
JTA TAMPA VÁLVULAS



13021 PAK
JTA COLETOR ESCAPE



13026 PAK
JTA ENTRE COLETORES



13027 PAK
JTA ESCAPE

JG JTA RETIFICAÇÃO



13031 GV
JTA BBA AGUA



13331 GV
JTA BBA OLEO



59840 NA
JTA TUBO ÓLEO



10296 NA
JTA BBA COMBÚSTIVEL



13033 NA
JTA FILTRO
GASOLINA



13035 NA
JTA



13335 NA
JTA SUPORTE BÓIA BBA ÓLEO



13036 BO
VBORRACHA LATERAL MANCAL



70019 A
GAXETA MANCAL TRAS



13132CB
JTA DISTRIBUIÇÃO



13034 NA
JTA BBA COMBUSTIVEL



13116 CB
JTA CARTER

XXXXX-KP
KIT PARAFUSOS DO CABEÇOTE

2.2 8V 4C - JEEP 54/58

MTR: HURICANE - GAS

13106-JGCB JG JTA MTR S/ CAB

13106-JGSC JG JTA MTR C/ CAB DE FIBRA

13106-JGRS JG RETIF MTR S/ CAB

13106-JGRV JG RETIF MTR C/ CAB DE FIBRA



13101 SC
JTA CABEÇOTE



13128 CB
JTA TAMPA VÁLVULAS

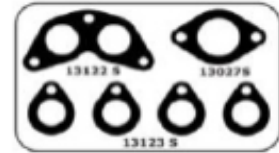

13121 PAK
JG JTA COLETOR ESCAPE



13130 CB
JTA TAMPA LATERAL VÁLVULAS

JG JTA RETIFICAÇÃO



13031 GV
JTA BBA AGUA



13331 GV
JTA BBA OLEO



13334 GV
JTA TAMPA BBA OLEO



10296 NA
JTA BBA COMBÚSTIVEL



10420 NA
JTA FLANGE CARBURADOR



13336 CB
JTA RESPIRO CARTER



262230
ANEL BUJÃO CARTER



13333 GV
JTA VÁLVULA TERMOSTÁTICO



13335 NA
JTA SUPORTE BÓIA BBA ÓLEO



13036 BO
BORRACHA LATERAL MANCAL



70019 A
GAXETA MANCAL TRAS.



13132CB
JTA DISTRIBUIÇÃO



13034 NA
JTA BBA COMBUSTIVEL



13116 CB
JTA CARTER

XXXXX-KP
KIT PARAFUSOS DO CABEÇOTE

2.2 16V 4C-FORD - RANGER 12/22 - TRANSIT 13/19

2.2 16V 4C-LAND ROVER - DEFENDER

MTR: DURATORQ PUMA TDCI(22DDOP) - DURATORQ-CYFA DSL TURBO - INJ DIR - DIESEL

12705-JGCB	JG JTA MTR S/ CAB	12705-JGRS	JG RETIF MTR S/ CAB
12705-JGSC	JG JTA MTR C/ CAB DE FIBRA	12705-JGRV	JG RETIF MTR C/ CAB DE FIBRA
12705-JGML	JG JTA MTR C/ CAB DE CHAPA	12705-JGRM	JG RETIF MTR C/ CAB DE CHAPA
12705-JRSC	JG JTA MTR C/ CAB DE FIBRA E C/ RET	12705-JRRV	JG RETIF MTR C/ CAB DE FIBRA E RET
12705-JRML	JG JTA MTR C/ CAB DE CHAPA E C/ RET	12705-JRRM	JG RETIF MTR C/ CAB DE CHAPA E RET



12701-1M-MLS - 1,10 MM - CIL. 87 MM
12701-2M-MLS - 1,15 MM - CIL. 87 MM
12701-3M-MLS - 1,20 MM - CIL. 87 MM
12701-3M-SC - 1,20 MM - CIL. 87 MM

JTA CABEÇOTE



12721 MLS
JTA COLETOR ESCAPE

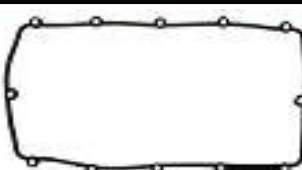

12725 BO - JTA TAMPA VÁLVULAS



12745 JGBO
VEDADORES BICO VELAS

OPCIONAL



12746 JGBO
VEDADORES PARAFUSOS TV

12725 KTBO 01 - KIT JTAS TAMPA VALVULAS- 7 PÇS



12733 PAK
JTA



12749 MLS
JTA



12720 JGBO
JTA COLETOR ADMISSÃO

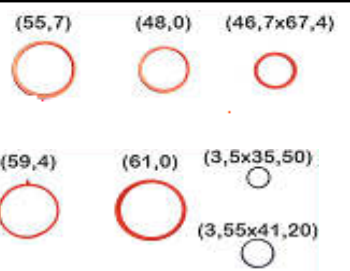

12705 KTBO - KIT VEDADORES MOTOR

JG JTA RETIFICAÇÃO



12737 MLS

12734 KTBM
KIT JTAS RADIADOR ÓLEO/TROCADOR CALOR

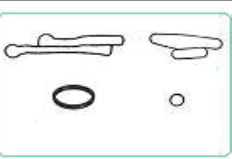

OPCIONAL

12743 KTBO
KIT JTAS RAD ÓLEO/TROCADOR CALOR

OPCIONAL



12730 MLS
JUNTA DA BOMBA D'AGUA



12736 MLS
JTA



12748 MLS
JTA



12741 PAK
JTA



12752 MLS - JTA D'AGUA



12742 MLS
JTA



12747 BO
JUNTA DA TAMPA FRONTAL



12743 MLS
JTA



12722 PAK
JTA ESCAPE



12743 MLS
JTA



12716 MLS
JTA CARTER



OPCIONAL

12751 KRNA - KIT VALV EGR

12705-KP
KIT PARAFUSOS DO CABEÇOTE
10.00X1.50X158.00(X10)
8.00X1.25X120.00(X8)

12705-KTRT OU 12705 KTRT-F (com ret flange tras.)
KIT DE RETENORES DO MOTOR

RET VALVULAS-07X12X19,5



1230083

FLANGE TRASEIRO



12705 FR

RET DIANT
50X90X8,5/13,5



1130183

2.2 16V 4C - RANGER / TRANSIT 11/13

MTR: **GBVAJPF / AQL / AQN - DURATORQ - DIESEL**

12708-JGCB	JG JTA MTR S/ CAB	12708-JGRS	JG RETIF MTR S/ CAB
12708-JGSC	JG JTA MTR C/ CAB DE FIBRA	12708-JGRV	JG RETIF MTR C/ CAB DE FIBRA
12708-JGML	JG JTA MTR C/ CAB DE CHAPA	12708-JGRM	JG RETIF MTR C/ CAB DE CHAPA
12708-JRSC	JG JTA MTR C/ CAB DE FIBRA E C/ RET	12708-JRRV	JG RETIF MTR C/ CAB DE FIBRA E RET
12708-JRML	JG JTA MTR C/ CAB DE CHAPA E C/ RET	12708-JRRM	JG RETIF MTR C/ CAB DE CHAPA E RET



12701-1M-MLS - 1,10 MM - CIL. 87 MM
 12701-2M-MLS - 1,15 MM - CIL. 87 MM
 12701-3M-MLS - 1,20 MM - CIL. 87 MM
 12701-3M-SC - 1,20 MM - CIL. 87 MM

JTA CABEÇOTE



12721 MLS
 JTA COLETOR ESCAPE



12726 BO - JTA TAMPÁ VÁLVULAS



12745 JGBO JTA BICO VELAS 12746 BO VED PARAFUSOS

12726 KTBO JTA TAMPÁ VALVULA



12749 DI-DIAFRAGMA DA T V

12726 KTBO-DI -KIT DE JTAS T V C/ DIAFRAGMA



12720 JGBO
 JTA COLETOR ADMISSÃO

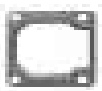

12722 PAK
 JTA ESCAPE

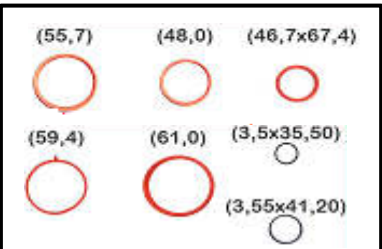

12705 KTBO - KIT VEDADORES MOTOR

JG JTA RETIFICAÇÃO



12730 MLS
 JUNTA DA BOMBA D'AGUA



12734 MLS
 JTA



12742 MLS
 JTA



12733 PAK
 JTA



12741 PAK
 JTA



12743 MLS
 JTA



12748 MLS
 JTA



12747 BO
 JUNTA DA TAMPÁ FRONTAL



12744 MLS
 JTA SAÍDA D'AGUA

OPCIONAL

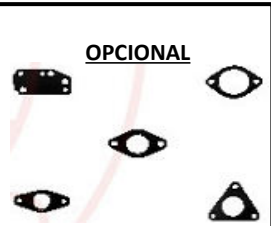

11586 CV - JOGO JUNTAS TURBINA

OPCIONAL



12735 KTBO
 FILTRO ÓLEO RANGER/TRANSIT 2.2/2.4 16V

OPCIONAL



12729 NA
 JTA DISTRIBUIÇÃO

OPCIONAL



12728 NA
 JTA DISTRIBUIÇÃO INTERNA



12737 MLS
 JTA



12716 MLS
 JTA CARTER

12705-KP
 KIT PARAFUSOS DO CABEÇOTE
 10.00X1.50X138.00 X10)
 8.00X1.25X120.00(X8)

12705-KTRT OU 12705 KTRT-F (com ret flange tras.)
 KIT DE RETENORES DO MOTOR

RET VALVULAS-07X12X19,5



1230083

FLANGE TRASEIRO



12705 FR

RET DIANT
 50X90X8,5/13,5



1130183

2.3 8V 4C - JEEP 76/82 - F-75 70/83 - MAVERICK 75/81 - F100 : 75/84

MTR: **GEORGIA SOHC - GAS**

11306-JGCB JG JTA MTR S/ CAB

11306-JGSC JG JTA MTR C/ CAB DE FIBRA

11306-JRSC JG JTA MTR C/ CAB DE FIBRA E C/ RET

11306-JGRS JG RETIF MTR S/ CAB

11306-JGRV JG RETIF MTR C/ CAB DE FIBRA

11306-JRRV JG RETIF MTR C/ CAB DE FIBRA E RET



11301 SC - 1,6 MM - CIL. 99,5 MM

OPCIONAL

11301 KT - 2,6 MM - CIL. 99,5 MM

11301-TB - 2,1 MM - CIL. 99,5 MM

JTA CABEÇOTE



11326 CB
JTA TAMPA VÁLVULAS



11323 PAK
JTA COLETOR ESCAPE



11322 NA - JTA ADMISSÃO(ALC)



11330 NA
JTA TPA COL ADM



11332 NA
JTA SAÍDA D AGUA



OR1-012



11321 NA-JTA ADMISSÃO(GAS)

JG JTA RETIFICAÇÃO



11348 NA
JTA VÁLVULA
RECIRCULADORA



11329 NA
JTA BBA AGUA



11337 JGBO
GAXETA MANCAL
TRAS.



11338 NA
JTA BBA OLEO



10296 NA
JTA BBA
COMBUSTIVEL



11324 NA
JTA BUJÃO
CARTER



11328 NA
JTA DISTRIBUIÇÃO



11325 GV
JTA ADPTATOR
FILTRO ÓLEO

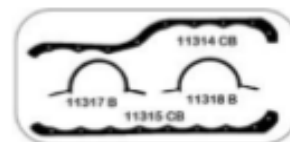

11316 CB
JTA CARTER

XXXXX-KP

KIT PARAFUSOS DO CABEÇOTE

11306-KTRT

KIT DE RETENORES DO MOTOR

RET VÁLVULAS

- RET COMANDO 43X56X09



11333 BO



1131943

RET GIRABREQUIM DIANTEIRO

43X56X09



1131943

2.3/2.5 8V 4C - FORD - RANGER 94/01

2.3/2.5 8V 4C - MAZDA - B2300 / B2500

MTR: 140 WLT / DURATEC - SOHC - GAS

11307-JGCB JG JTA MTR S/ CAB

11307--JGSC JG JTA MTR C/ CAB DE FIBRA

11307--JRSC JG JTA MTR C/ CAB DE FIBRA E C/ RET

11307--JGRS JG RETIF MTR S/ CAB

11307--JGRV JG RETIF MTR C/ CAB DE FIBRA

11307--JRRV JG RETIF MTR C/ CAB DE FIBRA E RET

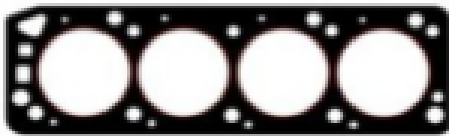

11301 SC - 1,6 MM - CIL. 99,5 MM

OPCIONAL

11301 KT - 2,6 MM - CIL. 99,5 MM

11301-TB - 2,1 MM - CIL. 99,5 MM

JTA CABEÇOTE



11327 BO
JTA TAMPA VÁLVULAS



11325 PAK
JTA COLETOR ESCAPE



11324 NA
JTA COLETOR ADMISSÃO

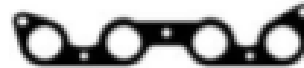

11319 NA
JTA COLETOR ADMISSÃO INTERNA

JG JTA RETIFICAÇÃO



11307 KT BO
KIT VEDADORES MOTOR



11339 NA
JTA ENTRADA AR



11334 NA
JTA BBA AGUA



11317 BO
JTA CARTER

11307-KTRT-8MM

KIT DE RETENORES DO MOTOR

RET VALVULAS-08X14X15



1230059

RET COMANDO-43X56X090



1131943

RET GIRABREQUIM DIANT

43X56X09



1131943

RET GIRABREQUIM TRAS.

92X108X9,5



1130059

11307-KTRT-6MM

KIT DE RETENORES DO MOTOR

RET VALVULAS-6,2X12X14



1230159

RET COMANDO-43X56X09



1131943

RET GIRABREQUIM DIANT

43X56X09



1131943

RET GIRABREQUIM TRAS.

92X108X9,5



1130059

2.3 16V 4C - RANGER 09/12 - FUSION 06/09

MTR: DURATEC (TV DE PLASTICO) - GAS

12208-JGCB	JG JTA MTR S/ CAB	12208-JGRS	JG RETIF MTR S/ CAB
12208-JGSC	JG JTA MTR C/ CAB DE FIBRA	12208-JGRV	JG RETIF MTR C/ CAB DE FIBRA
12208-JGML	JG JTA MTR C/ CAB DE CHAPA	12208-JGRM	JG RETIF MTR C/ CAB DE CHAPA
12208-JRSC	JG JTA MTR C/ CAB DE FIBRA E C/ RET	12208-JRRV	JG RETIF MTR C/ CAB DE FIBRA E RET
12208-JRML	JG JTA MTR C/ CAB DE CHAPA E C/ RET	12208-JRRM	JG RETIF MTR C/ CAB DE CHAPA E RET



12202 SC - 1,2 MM - CIL. 88 MM
12202 MLS - 0,5 MM - CIL. 88 MM

OPCIONAL

12202 KT - 2,2 MM - CIL. 88 MM
12202 MLS-3M - 2,0 MM - CIL. 88 MM

JTA CABEÇOTE

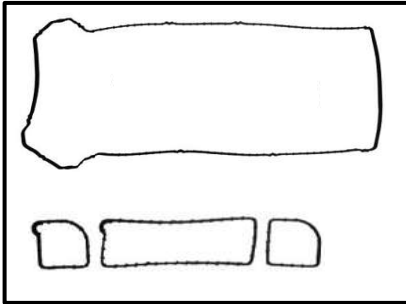

11527 KTBO - KIT JUNTAS TAMPA VÁLVULAS





11221 F
JTA COLETOR ESCAPE





12220 JGBO
JTA COLETOR ADMISSÃO



OPCIONAL

12285 BO VEDADOR ARANHA / CAIXA BORBOLETA 12222 F 12233 BO JUNTA DO

11155 NA 11158 NA
JTA VÁLVULA REGULADORA



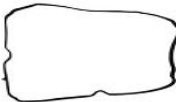



12230 BO JTA TPA RESPIRO ANTI CHAMA 12284 BO JTA 12232 BO JTA TERMOSTATO

12207 KTBO - KIT VEDADORES MOTOR

JG JTA RETIFICAÇÃO

OPCIONAL

OR1-225 ANEL ORING 47,22 X 3,53 MM OR1-210 ANEL ORING 19 X 3,53 MM 12247 BO ANEL BUJÃO CARTER



11153 NA
JTA SUPORTE FILTRO ÓLEO



11154 NA
JTA

12207-KP
KIT PARAFUSOS DO CABEÇOTE
10.00X1.25X145.00(X10)

12207-KTRT OU 12207 KTRT-F (com ret flange tras.)
KIT DE RETENORES DO MOTOR
RET VALV-5,5X11X18,5



1230073

RETENTOR DIANT GIRABREQUIM
37X50X08



1130073

FLANGE TRASEIRO



12207 FR

2.4 16V 4C - FORD - TRANSIT 08/11

2.4 16V 4C - LAND ROVER- DEFENDER 07/15

MTR: PUMA-JXF DSL TURBO INJ DIR - TD4 244DT DIESEL - PUMA JXF DIESEL

12705-JGCB	JG JTA MTR S/ CAB	12705-JGRS	JG RETIF MTR S/ CAB
12706-JGSC	JG JTA MTR C/ CAB DE FIBRA	12706-JGRV	JG RETIF MTR C/ CAB DE FIBRA
12706-JGML	JG JTA MTR C/ CAB DE CHAPA	12706-JGRM	JG RETIF MTR C/ CAB DE CHAPA
12706-JRSC	JG JTA MTR C/ CAB DE FIBRA E C/ RET	12706-JRRV	JG RETIF MTR C/ CAB DE FIBRA E RET
12706-JRML	JG JTA MTR C/ CAB DE CHAPA E C/ RET	12706-JRRM	JG RETIF MTR C/ CAB DE CHAPA E RET



12702-1M-MLS - 1,10 - CIL. 91 MM
12702-2M-MLS - 1,15 - CIL. 91 MM
12702-3M-MLS - 1,20 - CIL. 91 MM
12702-3M-SC - 1,20 - CIL. 91 MM

JTA CABEÇOTE



12721 MLS
JTA COLETOR ESCAPE



12726 BO
JTA TAMPA VÁLVULAS



12745 JGBO
VED. BICO VELAS



12746 BO
VED PARAFUSOS

12726 KTBO - KIT DE JTAS DA T V



12749 DI - DIAFRAGMA DA T V

12726 KTBO-DI -KIT DE JTAS T V C/ DIAFRAGMA

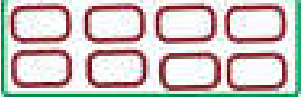

12720 JGBO - JTA COLETOR ADMISSÃO

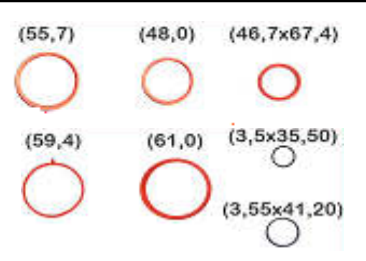

12705 KTBO
KIT VEDADORES MOTOR

JG JTA RETIFICAÇÃO



12743 MLS
JTA



12730 MLS
JUNTA DA BOMBA D'AGUA



12734 MLS
JTA



12742 MLS
JTA



12744 MLS
JTA



12737 MLS



12734 KTBM
KIT JTAS RADIADOR ÓLEO/TROCADOR CALOR



12748 MLS
JTA



12722 PAK
JTA ESCAPE



12747 PAK
JTA



OPCIONAL

12729 NA - JTA DISTRIBUIÇÃO



OPCIONAL

12728 NA
JTA DISTRIBUIÇÃO INTERNA



12716 MLS
JTA CARTER

12705-KP
KIT PARAFUSOS DO CABEÇOTE
10.00X1.50X158.00 (x10)
8.00X1.25X120.00(X8)

12705-KTRT OU 12705 KTRT-F (com ret flange tras.)
KIT DE RETENORES DO MOTOR

RET VALVULAS-07X12X19,5



1230083

FLANGE TRASEIRO



12705 FR

RET DIANT
50X90X8,5/13,5



1130283

2.5 8V 4C - GM - S10 95/00 - BLAZER: 97/00

2.5 8V 4C - FORD - F1000 96/98 - RANGER 97/01

2.5 8V 4C - MB - SPRINTER 96/01

2.5 8V 4C - LAND ROVER - DISCOVERY / DEFENDER: 98/05

MTR: MAXION HS 310D / 312 D - TDI - DIESEL

70106-JGCB	JG JTA MTR S/ CAB	70106-JGRS	JG RETIF MTR S/ CAB
70106-JGSC	JG JTA MTR C/ CAB DE FIBRA 3M	70106-JGRV	JG RETIF MTR C/ CAB DE FIBRA 3M
70106-JGML	JG JTA MTR C/ CAB DE CHAPA 3M	70106-JGRM	JG RETIF MTR C/ CAB DE CHAPA 3M
70106-JRSC	JG JTA MTR C/ CAB DE FIBRA 3M E C/ RET	70106-JRRV	JG RETIF MTR C/ CAB DE FIBRA 3M E RET
70106-JRML	JG JTA MTR C/ CAB DE CHAPA 3M E C/ RET	70106-JRRM	JG RETIF MTR C/ CAB DE CHAPA 3M E RET



70101 SC-1M - 1,37 MM - CIL. 92 MM
 70101 SC-2M - 1,45 MM - CIL. 92 MM
 70101 SC-3M - 1,60 MM - CIL. 92 MM
 70101 MLS-1M - 1,37 MM - CIL. 92 MM
 70101 MLS-2M - 1,48 MM - CIL. 92 MM
 70101 MLS-3M - 1,60 MM - CIL. 92 MM
 70101 MLS-4M - 2,00 MM - CIL. 92 MM
 JTA CABEÇOTE



70145 NA
JTA BBA D'AGUA



70144 NA
JTA TERMOSTATO



70127 BO -- JTA TAMPA VÁLVULAS



70244 BO - VEDADOR TAMPA VÁLVULAS

70127 KTBO - KIT JTA TAMPA VÁLVULAS



70142 NA
JTA BBA D'AGUA



70149 NA
JTA FILTRO ÓLEO



70151 NA
JTA BBA INJETORA



70120 F
JTA COL ETOR ESCAPE

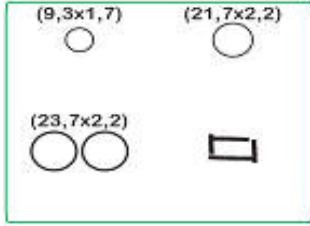

70106 KTBO
KIT VEDADORES MOTOR

JG JTA RETIFICAÇÃO



70146 NA
JTA TUBO INSPEÇÃO



70148 NA
JTA BBA VÁCUO



70134 NA
JTA



70135 NA
JTA PAVIO VEDAÇÃO



10296 NA
JTA BBA COMBÚSTIVEL



70152 NA
JTA RETENTOR TRASEIRO





70141 NA
JTA TAMPA DISTRIBUIÇÃO



70140 NA
JTA DISTRIBUIÇÃO INTERNA



70115 CBLT
JTA CARTER

<p>70106-KP</p> <p>KIT PARAFUSOS DO CABEÇOTE</p> <p>10.00X1.50X117.00 (X4)</p> <p>12.00X1.50X100.00 (X4)</p> <p>12.00X1.50X140.00 (X10)</p>	<p>70106 KTRT OU 70106 KTRT-F (com flange)</p> <p>KIT DE RETENORES DO MOTOR</p> <p>RET VALVULAS-08X12X11 RET CMD 46.7X62.3X09</p>  <p>1222396 1150009</p> <p>FLANGE RET DIANT</p>  <p>70106 FR 60,71X79,37X9,5</p>  <p>1150109</p>
---	--

2.5 12V 4C - FORD - RANGER D / RANGER TD

2.5 12V 4C - MAZDA - B2500 MPV 99/06

MTR: WLT - DIESEL / TURBO DIESEL

12405-JGCB JG JTA MTR S/ CAB

12405-JGSC JG JTA MTR C/ CAB DE FIBRA

12405-JGML JG JTA MTR C/ CAB DE CHAPA

12405-JRSC JG JTA MTR C/ CAB DE FIBRA E C/ RET

12405-JRML JG JTA MTR C/ CAB DE CHAPA E C/ RET

12405-JGRS JG RETIF MTR S/ CAB

12405-JGRV JG RETIF MTR C/ CAB DE FIBRA

12405-JGRM JG RETIF MTR C/ CAB DE CHAPA

12405-JRRV JG RETIF MTR C/ CAB DE FIBRA E RET

12405-JRRM JG RETIF MTR C/ CAB DE CHAPA E RET



12404 MLS - CIL. 94,5 MM
JTA CABEÇOTE

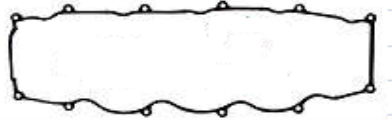

12426 BO
JTA TAMPA VÁLVULAS



12463 PAK
GAXETA ESCAPE



12421 PAK / F
JTA COLETOR ESCAPE



12420 PAK
JTA COLETOR ADMISSÃO



12422 PAK
JTA ESCAPE

JG JTA RETIFICAÇÃO



12434 NA
JTA TROCADOR CALOR



12430 NA
JTA BBA AGUA

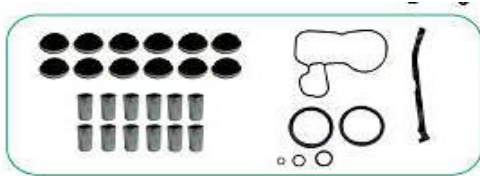

12405 KTBO - KIT VEDADORES MOTOR



12416 NA
JTA CARTER

12405-KP

KIT PARAFUSOS DO CABEÇOTE

10.00X1.25X101.00 (x8)

12.00X1.50X113.00 (x10)

12406-KTRT

KIT DE RETENORES DO MOTOR

RET VALVULAS



1250112

RET GIRABREQUIM DIANT



RET COMANDO-32X46X07



1150050

RET GIRABREQUIM TRAS

90X110X09



1150296

2.5 16V 4C-FORD - RANGER 12/19 - FUSION 09/18 - ESCAPE 14/18 - FUSION HÍBRID 10/15

2.5 16V 4C-VOLVO - C30 / V50: 06/12 - V70 97/00

MTR: DURATEC/ATKINSON/GASOLINA/ELETRICO - DURATEC FLEX - VOLVO: B4204S GAS

12210-JGCB	JG JTA MTR S/ CAB	12210-JGRS	JG RETIF MTR S/ CAB
12210-JGSC	JG JTA MTR C/ CAB DE FIBRA	12210-JGRV	JG RETIF MTR C/ CAB DE FIBRA
12210-JGML	JG JTA MTR C/ CAB DE CHAPA	12210-JGRM	JG RETIF MTR C/ CAB DE CHAPA
12210-JRSC	JG JTA MTR C/ CAB DE FIBRA E C/ RET	12210-JRRV	JG RETIF MTR C/ CAB DE FIBRA E RET
12210-JRML	JG JTA MTR C/ CAB DE CHAPA E C/ RET	12210-JRRM	JG RETIF MTR C/ CAB DE CHAPA E RET



12203 SC - 1,2 MM - CIL. 89 MM
12203 MLS - 0,5 MM - CIL. 89 MM

OPCIONAL

12203 KT - 3,0 MM - CIL. 89 MM
12203 MLS-1M - 1,0 MM - CIL. 89 MM
12203 MLS-2M - 1,5 MM - CIL. 89 MM
12203 MLS-3M - 2,0 MM - CIL. 89 MM

JTA CABEÇOTE

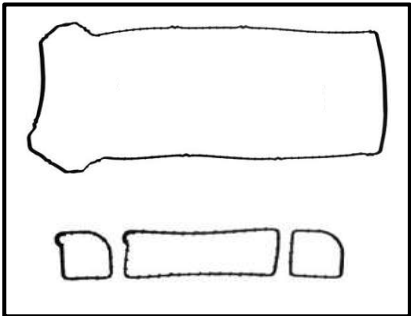

11527 KTBO - KIT JTAS TAMPA VÁLVULAS



11158 NA
JTA VÁLVULA REGULADORA VENTILAÇÃO MOTOR



11155 NA
JTA CONEXÃO SAÍDA D AGUA



12221 F
JTA COLETOR ESCAPE



12220 JGBO
JTA COLETOR ADMISSÃO



12230 BO
JTA TPA RESPIRO ANTI CHAMA



12284 BO
JTA IE



12232 BO
JTA TERMOSTATO

12207 KTBO - KIT VEDADORES MOTOR

JG JTA RETIFICAÇÃO

OPCIONAL



OR1-225
ANEL ORING
47,22 X 3,53 MM



OR1-210
ANEL ORING
19 X 3,53 MM



12247 BO
ANEL DO BUJÃO DO CARTER



11153 NA
JTA SUPORTE FILTRO ÓLEO



11154 NA
JTA

12207-KP
KIT PARAFUSOS DO CABEÇOTE
10.00X1.25X145.00(X10)

12207-KTRT OU 12207 KTRT-F (com ret flange tras.)
KIT DE RETENORES DO MOTOR
RET VALV-5,5X11X18,5



1230073

RETENTOR DIANT GIRABREQUIM
37X50X08



1130073

FLANGE TRASEIRO



12207 FR

2.5 24V V6 - MONDEO 96/07

MTR: SEA GUIA - GAS

12306-JGCB JG JTA MTR S/ CAB

12306-JGML JG JTA MTR C/ CAB DE CHAPA

12306-JRML JG JTA MTR C/ CAB DE CHAPA E C/ RET

12306-JGRS JG RETIF MTR S/ CAB

12306-JGRM JG RETIF MTR C/ CAB DE CHAPA

12306-JRRM JG RETIF MTR C/ CAB DE CHAPA E RET



12301/2 MLS - CIL. 91,5 MM
JTA CABEÇOTE

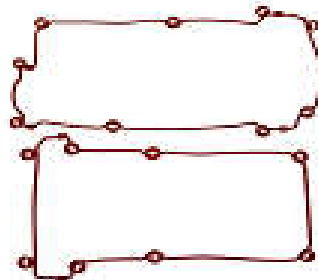

12326 KTBO
JTA TAMPA VÁLVULAS



12321 MLS / F
JTA COLETOR ESCAPE



12320 KTBO
JTAS COLETOR ADMISSÃO



12319 NA
JTAS COLETOR ADMISSÃO



12318 NA
JTAS COLETOR ADMISSÃO

JG JTA RETIFICAÇÃO



12330 NA
JTA BBA AGUA

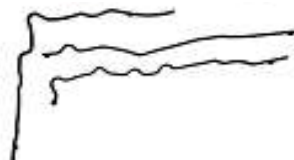

12306 KTBO
JG VEDADORES MOTOR



12316 BI
JTA CARTER

12306-KP

KIT PARAFUSOS DO CABEÇOTE
10.00X1.50X154.00 (X16)

12306-KTRT

KIT DE RETENORES DO MOTOR

RET VALV-5,5X12,3X18,5

RET COMANDO-47X63,5X8,5



Nº ORIG: 12025500



Nº ORIG: 15056500

RET GIRABREQUIM TRASEIRO-91X107,5X9,5



Nº ORIG: 15052700

2.6 12V 6C - FORD - MAVERICK

2.6 12V 6C - WILLYS - JEEP / RURAL / F75 / AERO: 60/75

MTR: E2600 - GAS

13306-JGCB JG JTA MTR S/ CAB

13306-JGSC JG JTA MTR C/ CAB DE FIBRA

13306-JGRS JG RETIF MTR S/ CAB

13306-JGRV JG RETIF MTR C/ CAB DE FIBRA



13301 SC - FIBRA

"OPCIONAL"

13301 FA - REVESTIDA DE FOLHA
13301 KT - SOB MEDIDA

JTA CABEÇOTE



10537 NA
JTA BASE CARBURADOR



13337 CB
JTA TAMPA VALVULAS



13321 PAK
JTA COLETOR ADMISSÃO E ESCAPE



13330 GV
JTA BBA D'AGUA

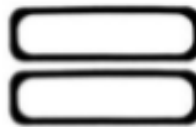

13326 CB
JTA TAMPA LATERAL
VALVULAS

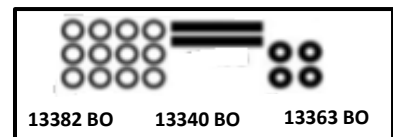

13306 KTBO - KIT VEDADORES MOTOR

JG JTA RETIFICAÇÃO



10296 NA
JTA BBA COMBUSTÍVEL



13334 GV
JTA TAMPA BBA ÓLEO



13331 GV
JTA BBA ÓLEO



13336 CB
JTA RESPIRO CARTER



13328 GV
JTA DIANTEIRA BLOCO



13349 GV
JTA BBA ÓLEO



13333 GV
JTA ENTRADA AGUA CABEÇOTE



13347 GV
JTA BBA ÓLEO



13335 GV
JTA SUPORTE BBA ÓLEO



13327 CB
JTA DISTRIBUIÇÃO



70019 A
GAXETA MANCAL
TRASEIRO



13316 CB
JTA CARTER

2.8 8V 4C - RANGER 01/06

MTR: POWER STROKE-WG B60 DSL TURBO INJ DIR - TURBO DIESEL

70107-JGCB	JG JTA MTR S/ CAB	70107-JGRS	JG RETIF MTR S/ CAB
70107-JGSC	JG JTA MTR C/ CAB DE FIBRA 3M	70107-JGRV	JG RETIF MTR C/ CAB DE FIBRA 3M
70107-JGML	JG JTA MTR C/ CAB DE CHAPA 3M	70107-JGRM	JG RETIF MTR C/ CAB DE CHAPA 3M
70107-JRSC	JG JTA MTR C/ CAB DE FIBRA 3M E C/ RET	70107-JRRV	JG RETIF MTR C/ CAB DE FIBRA 3M E RET
70107-JRML	JG JTA MTR C/ CAB DE CHAPA 3M E C/ RET	70107-JRRM	JG RETIF MTR C/ CAB DE CHAPA 3M E RET



OPCIONAL

70102 SC-1M - 1,35 MM - CIL. 94 MM
 70102 SC-2M - 1,45 MM - CIL. 94 MM
 70102 SC-3M - 1,60 MM - CIL. 94 MM
 70102 MLS-1M - 1,35 MM - CIL. 94 MM
 70102 MLS-2M - 1,45 MM - CIL. 94 MM
 70102 MLS-3M - 1,60 MM - CIL. 94 MM

JTA CABEÇOTE



70145 NA
JTA BBA D'AGUA



70144 NA
JTA TERMOSTATO

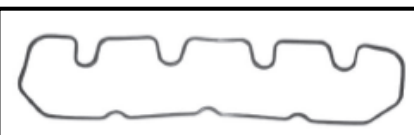

70127 BO -- JTA TAMPA VÁLVULAS



70244 BO - VEDADOR TAMPA VÁLVULAS

70127 KTBO - KIT JTA TAMPA VÁLVULAS



70142 NA
JTA BBA D'AGUA



70149 NA
JTA FILTRO ÓLEO



70151 NA
JTA BBA INJETORA



70120 F
JTA COL ETOR ESCAPE

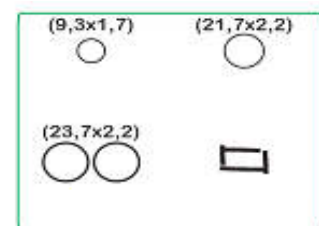

70106 KTBO - KIT VEDADORES MOTOR

JG JTA RETIFICAÇÃO



70146 NA
JTA TUBO INSPEÇÃO



70152 NA
JTA RETENTOR TRASEIRO



70148 NA
JTA BBA VÁCUO



70141 NA
JTA TAMPA DISTRIBUIÇÃO



70134 NA
JTA



70140 NA
JTA DISTRIBUIÇÃO INTERNA







70135 NA
JTA PAVIO VEDAÇÃO



70115 CBLT
JTA CARTER



10296 NA
JTA BBA COMBÚSTIVEL

<p>70106-KP</p> <p>KIT PARAFUSOS DO CABEÇOTE</p> <p>10.00X1.50X117.00 (X4) 12.00X1.50X100.00 (X4) 12.00X1.50X140.00 (X10)</p>	<p>70106 KTRT OU 70106 KTRT-F (com flange)</p> <p>KIT DE RETENORES DO MOTOR</p> <p>RET VALVULAS-08X12X11 RET CMD 46.7X62.3X09</p>  <p>1222396 FLANGE</p>  <p>70106 FR</p>  <p>1150009 RET DIANT</p> <p>60,71X79,37X9,5</p>  <p>1150109</p>
---	---

2.8 12V 4C - GM - S10 / BLAZER : 00/ - MTR SPRINT 4.07TCA DIESEL - MECÂNICO / ELETRÔNICO

2.8 12V 4C - FORD - TROLLER - MTR SPRINT 4.07TCA DIESEL - MECÂNICO / ELETRÔNICO

2.8 12V 4C - NISSAN - X-TERRA / FRONTIER - MTR SPRINT 4.07TCA DIESEL - MECÂNICO / ELETRÔNICO

2.8 12V 4C - VW - 5 140 / 8 150 / 9 150 / DELIVERY 8 140 / DELIVERY 8 150

2.8 12V 4C - AGRALE - AGRALE: 6000 / TD MICRO ÔNIBUS -MTR SPRINT 4.07TCA DIESEL - MEC / ELETRÔNICO

2.8 12V 4C - VOLARE - A5 / A6 / A8 - MTR SPRINT 4.07TCA DIESEL - MECÂNICO / ELETRÔNICO

MTR: SPRINT 4.07TCA DIESEL - MECÂNICO / ELETRÔNICO

71004-JGCB	JG JTA MTR S/ CAB	71004-JGRS	JG RETIF MTR S/ CAB
71004-JGSC	JG JTA MTR C/ CAB DE FIBRA	71004-JGRV	JG RETIF MTR C/ CAB DE FIBRA
71004-JGML	JG JTA MTR C/ CAB DE CHAPA	71004-JGRM	JG RETIF MTR C/ CAB DE CHAPA
71004-JRSC	JG JTA MTR C/ CAB DE FIBRA E C/ RET	71004-JRRV	JG RETIF MTR C/ CAB DE FIBRA E RET
71004-JRML	JG JTA MTR C/ CAB DE CHAPA E C/ RET	71004-JRRM	JG RETIF MTR C/ CAB DE CHAPA E RET



OPCIONAL

71002 MLS - 1,5 MM - CIL. 96 MM
 71002 MLS-1M - 1,7 MM - CIL. 96 MM
 71002-1M-SC - 1,4 MM - CIL. 96 MM
 71002-KT - 2,4 MM - CIL. 96 MM



71076 BO-JTA DA TAMPA DE VÁLVULAS



71079 BO-VEDADORES DA T V



71321 PAK / F
JTA COLETOR ESCAPE

71022 F
JTA ESCAPE

71082 NA
JTA BASE TERMOSTATO



71122 CB - JTA COLETOR ADMISSÃO

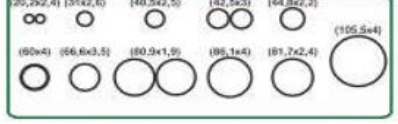

71004 KTBO - KIT VEDADORES MOTOR

JG JTA RETIFICAÇÃO



71035 NA
JTA RADIADOR ÓLEO 4.08



71031 NA
JTA RESFRIADOR ÓLEO



80033 NA
JTA RETORNO ÓLEO



70369 NA
JTA BBA INJ



71036 NA
JTA RESFRIADOR ÓLEO



71033 NA
JTA ADMISSÃO PEQ.



71079 PAK
JTA RAD ÓLEO



71077 NA
JTA RAD ÓLEO



71080 NA
JTA BBA OLEO

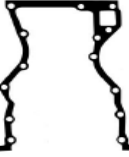

71078 NA
JTA DISTRIBUIÇÃO



71096 NA
JTA CARTER

71004-KP

KIT PARAFUSOS DO CABEÇOTE

14.00X2.00X165.00 (X10)

71004-KTRT

KIT DE RETENORES DO MOTOR

RET VALVULAS-07X11X10



1250058

RET VIRABREQUIM DIANT

64X80X09



1150058

RET VIRABREQUIM TRAS.

90,5X111X10



1150158

2.8 16V 4C AGRALE - MARRUÁ AM: 100 A 300: 12/21

2.8 16V 4C FORD - F350 /F4000: 14/19

2.8 16V 4C JAC - T140 14/19

2.8 16V 4C VOLARE - CINCO 16/19 - FLY 19/

2.8 16V 4C VW - 4-150/6-160/EXPRESS: 17/ - 4-160 20/

MTR: ISF 2.8 DSL TURBO INJ DIR

60006-JGCB	JG JTA MTR S/ CAB	60006-JGRS	JG RETIF MTR S/ CAB
60006-JGSC	JG JTA MTR C/ CAB DE FIBRA	60006-JGRV	JG RETIF MTR C/ CAB DE FIBRA
60006-JGML	JG JTA MTR C/ CAB DE CHAPA	60006-JGRM	JG RETIF MTR C/ CAB DE CHAPA
60006-JRSC	JG JTA MTR C/ CAB DE FIBRA E C/ RET	60006-JRRV	JG RETIF MTR C/ CAB DE FIBRA E RET
60006-JRML	JG JTA MTR C/ CAB DE CHAPA E C/ RET	60006-JRRM	JG RETIF MTR C/ CAB DE CHAPA E RET



60403 MLS - 1,15 MM - CIL. 95 MM
JUNTA CABEÇOTE



60020 PAK
JUNTA COLETOR ADMISSÃO



60026 BO
JUNTA DA TAMPA DE VALVULAS



60045 JGBO
JUNTA DA TAMPA DE VALVULAS

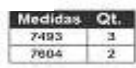

Medidas	Qt.
7493	3
7604	2

60006 KTAR
KIT ARRUELAS MOTOR



60024 MLS
JUNTA COLETOR ESCAPE

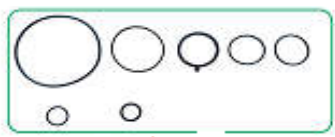

60006 KTBO - KIT BORRACHAS MOTOR

JG JTA RETIFICAÇÃO



60035 PAK
JUNTA BOMBA HIDRÁULICA



60006 KTAR
KIT BORRACHAS



60042 BO
JTA TPA CORRENTE



60041 KTBO - JUNTA

60029 KTBO
KIT JUNTA DISTRIBUIÇÃO



60034 BO
JUNTA



60029 MLS
JUNTA DISTRIBUIÇÃO

60044 KTBN
JUNTA BOMBA ÓLEO/
RADIADOR



60086 MLS
KIT JUNTA TURBINA



60016 BO
JUNTA CARTER

XXXXX-KP

KIT PARAFUSOS DO CABEÇOTE

60006-KTRT

KIT DE RETENORES DO MOTOR

RET HASTE VALVULAS

DIVERSAS



60049 DI

60026 BO DI
KIT TV C/ DIAFRAGMA

60026 KTBO DI
KIT JUNTA DA TAMPA DE VALVULAS C/ DIAFRAGMA



60046 JGBO
ANEL TV



60047 JGBO
RETENTOR TUBO VENTILÇÃO ÓLEO



60045 JGBO



129001019



119011019



119021019

3.0 16V 4C-FORD - RANGER FULL BR INTERCOOLER 08/10/2007/...

3.0 16V 4C-TROLLER - T4: 08/10/2007/...

MTR: NGD MWM POWER STROKE INTERCOOLER - DIESEL

70105-JGCB	JG JTA MTR S/ CAB	70105-JGRS	JG RETIF MTR S/ CAB
70105-JGSC	JG JTA MTR C/ CAB DE FIBRA 3M	70105-JGRV	JG RETIF MTR C/ CAB DE FIBRA 3M
70105-JRSC	JG JTA MTR C/ CAB DE FIBRA 3M E C/ RET	70105-JRRV	JG RETIF MTR C/ CAB DE FIBRA 3M E RET



OPCIONAL

- 70104-MLS-1M - 1,20 MM - CIL 98 MM
 - 70104-MLS-2M - 1,30 MM - CIL 98 MM
 - 70104-MLS-3M - 1,40 MM - CIL 98 MM
 - 70104-SC-1M - 1,20 MM - CIL 98 MM
 - 70104-SC-3M - 1,40 MM - CIL 98 MM
 - 70104-SC-4M - 1,50 MM - CIL 98 MM
 - 70104-SC-6M - 1,70 MM - CIL 98 MM
- JTA CABEÇOTE

70154 BO - JTA TAMPA DE VALVULAS

70146 JGBO - VEDADOR INJETOR

70154 KTBO 01 - JTA TAMPA DE VÁLVULAS

70147 JGBO - VEDADOR BICO VELA



70118 F - JTA COLETOR ADMISSÃO



70121 F
JTA COLETOR ESCAPE

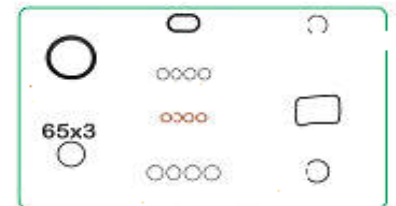

70105 KTBO - KIT BORRACHAS MOTOR

70154 KTBO - JTA TAMPA VÁLVULAS C/ VEDADOR INJETOR

JG JTA RETIFICAÇÃO

70158 BO
JTA ENTRA AGUA BLOCO

70124 BO
JTA DISTRIBUIÇÃO

70174 BO
JTA BBA INJETORA

70160 BO
JTA ENTRADA AGUA

70175 BO
ANEL

70124 KTBO
KIT JUNTAS DISTRIBUIÇÃO ÓLEO

70157 NA
JTA FLANGE DIANTEIRO

70135 NA
JTA TUBULAÇÃO AGUA

OPCIONAL

70134 BO 01 **70134 BO 02**

70134 NA - JTA TROCADOR CALOR

70138 KTNA - KIT JTAS TROCADOR CALOR

OPCIONAL

70162 BO
JUNTA DA BOMBA DA AGUA

70133 NA
JTA DISTRIBUIÇÃO

70115 NA
JTA CARTER

70105-KP
KIT PARAFUSOS DO CABEÇOTE
12.00X1.50X140.50(X10)

70105-KTRT OU 70105-KTRT-F
KIT DE RETENTORES DO MOTOR

RET VALV-06X12X19,5

1230049

RET GIRABREQUIM DIANTEIRO - FLANGE TRASEIRA

60.71X79.37X9,5

1150109

70105 FR

3.0 12V V6 - RANGER (SPLASH) / TAURUS / AEROSTAR: 85/95

MTR: VULCAN OHV - GAS

12106-JGCB	JG JTA MTR S/ CAB	12106-JGRS	JG RETIF MTR S/ CAB
12106-JGSC	JG JTA MTR C/ CAB DE FIBRA	12106-JGRV	JG RETIF MTR C/ CAB DE FIBRA
12106-JRSC	JG JTA MTR C/ CAB DE FIBRA E C/ RET	12106-JRRV	JG RETIF MTR C/ CAB DE FIBRA E RET



12103/4 SC - CIL. 91,5 MM
JTA CABEÇOTE

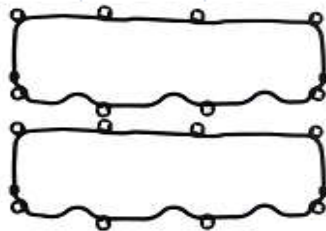

12126 JGBO
JTA TAMPA VÁLVULAS



12121 F
JTA COLETOR ESCAPE



12120 JGPAK
JTA COLETOR ADMISSÃO



12324/5 KTCB
JTA ADMISSÃO



12119 NA
JTA ADMISSÃO INTERNA



12132 NA
JTA TERMOSTATO

12120 KTPAK - JTA DE ADMISSÃO

JG JTA RETIFICAÇÃO



12130 NA
JTA BBA D'AGUA



12129 NA
JTA DISTRIBUIÇÃO



12116 BO
JTA CARTER

XXXXX-KP
KIT PARAFUSOS DO CABEÇOTE

12106-KTRT
KIT DE RETENORES DO MOTOR



RET VALVULAS

RET GIRABREQUIM DIANT

RET GIRABREQUIM TRAS

47X65/80X15

88X108X10



1130249

3.0 16V 4C FORD - RANGER FULL BR INTERCOOLER: 2005 a 09/2007.

3.0 16V 4C TROLLER - TROLLER T4: 2005 a 09/2007.

MTR: NGD MWM POWER STROKE INTERCOOLER - DIESEL

70108-JGCB	JG JTA MTR S/ CAB	70108-JGRS	JG RETIF MTR S/ CAB
70108-JGSC	JG JTA MTR C/ CAB DE FIBRA 3M	70108-JGRV	JG RETIF MTR C/ CAB DE FIBRA 3M
70108-JRSC	JG JTA MTR C/ CAB DE FIBRA 3M E C/ RET	70108-JRRV	JG RETIF MTR C/ CAB DE FIBRA 3M E RET



OPCIONAL

70104-MLS-1M - 1,20 MM - CIL 98 MM
 70104-MLS-2M - 1,30 MM - CIL 98 MM
 70104-MLS-3M - 1,40 MM - CIL 98 MM
 70104-SC-1M - 1,20 MM - CIL 98 MM
 70104-SC-3M - 1,40 MM - CIL 98 MM
 70104-SC-4M - 1,50 MM - CIL 98 MM
 70104-SC-6M - 1,70 MM - CIL 98 MM

JTA CABEÇOTE

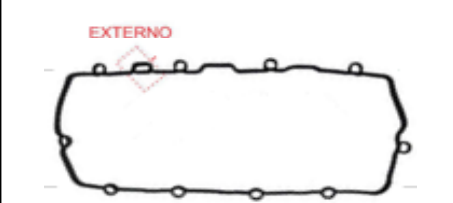

70155 BO - JTA TAMPA DE VÁLVULAS



70146 JGBO VEDADOR INJETOR



70147 JGBO VEDADOR BICO VELA



70118 F - JTA COLETOR ADMISSÃO



70121 F - JTA COLETOR ESCAPE

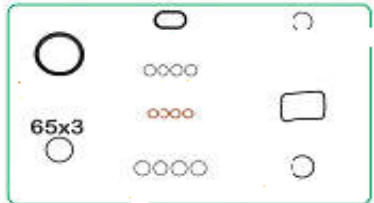

70105 KTBO - KIT BORRACHAS MOTOR

70155 KTBO
JTA TAMPA VÁLVULAS C/ VEDADOR INJETOR

JG JTA RETIFICAÇÃO



70124 BO
JTA DISTRIBUIÇÃO



70160 BO
JTA ENTRADA AGUA



70158 BO
JTA ENTRA AGUA BLOCO



70174 BO
JTA BBA INJETORA



70175 BO
ANEL



70157 NA
JTA FLANGE DIANTEIRO

OPCIONAL

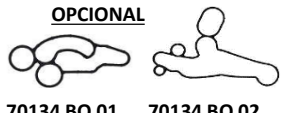

70134 BO 01 70134 BO 02



70134 NA - JTA TROCADOR CALOR



70135 NA
JTA TUBULAÇÃO AGUA



70133 NA
JTA DISTRIBUIÇÃO

OPCIONAL



70162 BO
JUNTA DA BOMBA DA AGUA



70115 NA
JTA CARTER

70124 KTBO
KIT JUNTAS DISTRIBUIÇÃO ÓLEO

70138 KTNA - KIT JTAS TROCADOR CALOR

70105-KP
KIT PARAFUSOS DO CABEÇOTE
12.00X1.50X140.50(X10)

70105-KTRT OU 70105-KTRT-F
KIT DE RETENTORES DO MOTOR

RET VALV-06X12X19,5



1230049

RET GIRABREQUIM DIANTEIRO - FLANGE TRASEIRA

60.71X79.37X9,5



1150109



70105 FR

3.2 20V 5C - FORD - RANGER 12/22

3.2 20V 5C - TROLLER - T4 14/22

MTR: DURATORQ-SAFA DSL TURBO - MAXXFORCE 3.2HEGRTURBO: INJ DIR - DIESEL

12707-JGCB	JG JTA MTR S/ CAB	12707-JGRS	JG RETIF MTR S/ CAB
12707-JGSC	JG JTA MTR C/ CAB DE FIBRA	12707-JGRV	JG RETIF MTR C/ CAB DE FIBRA
12707-JGML	JG JTA MTR C/ CAB DE CHAPA	12707-JGRM	JG RETIF MTR C/ CAB DE CHAPA
12707-JRSC	JG JTA MTR C/ CAB DE FIBRA E C/ RET	12707-JRRV	JG RETIF MTR C/ CAB DE FIBRA E RET
12707-JRML	JG JTA MTR C/ CAB DE CHAPA E C/ RET	12707-JRRM	JG RETIF MTR C/ CAB DE CHAPA E RET



12703 MLS-1M - 1,10 MM - CIL. 91 MM
12703 MLS-2M - 1,15 MM - CIL. 91 MM
12703 MLS-3M - 1,20 MM - CIL. 91 MM
12703 SC-3M - 1,20 MM - CIL. 91 MM
JTA CABEÇOTE



12723 MLS - JTA COLETOR ESCAPE

OPCIONAL



12727 BO
JTA TAMPA VÁLVULAS



12750 JGBO
JTA BICO VELAS



12751 JGBO
VED PARAFUSOS



12719 JGBO - JTA COLETOR ADMISSAO

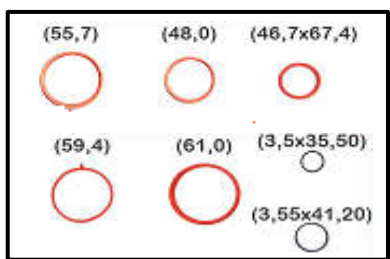

12705 KTBO - KIT VEDADORES MOTOR

JG JTA RETIFICAÇÃO

OPCIONAL



12730 MLS
JUNTA DA BOMBA D'AGUA

OPCIONAL



12744 KTBO
JTA RADIADOR ÓLEO

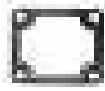

12737 MLS
JTA



12742 MLS
JTA



12743 MLS
JTA



12752 MLS
JTA D'AGUA



12747 BO
JUNTA DA TAMPA FRONTAL



12749 MLS
JTA



12717 MLS
JTA CARTER

12707-KP
KIT PARAFUSOS DO CABEÇOTE
10.00X1.50X158.00 (X12)
8.00X1.25X120.00 (X10)

12707-KTRT OU 12707 KTRT-F (com ret flange tras.)
KIT DE RETENORES DO MOTOR
RET VALVULAS-07X12X19,5



1230083

FLANGE TRASEIRO



12705 FR

RET DIANT
50X90X8,5/13,5



1130283

3.6 12V 6C - F1000 / FALCON : 82/96

MTR: 221 - GAS

12006-JGCB JG JTA MTR S/ CAB

12006-JGSC JG JTA MTR C/ CAB DE FIBRA

12006-JRSC JG JTA MTR C/ CAB DE FIBRA E C/ RET

12006-JGRS JG RETIF MTR S/ CAB

12006-JGRV JG RETIF MTR C/ CAB DE FIBRA

12006-JRRV JG RETIF MTR C/ CAB DE FIBRA E RET



12601 SC
JTA CABEÇOTE



12027 CB
JTA TAMPA VÁLVULAS



10334 PAK
GAXETA ESCAPE



11921 PAK
JTA COLETOR ESCAPE

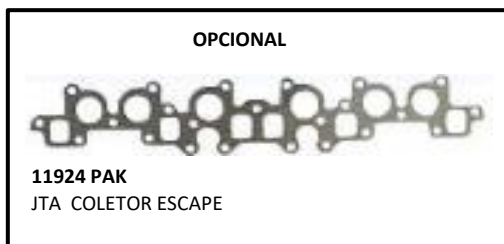

11924 PAK
JTA COLETOR ESCAPE



11919 PAK
JTA COLETOR ESCAPE

JG JTA RETIFICAÇÃO



11369 NA
JTA BASE
AQUECEDOR



10169 NA
JTA BASE
CARBURADOR



43015 NA
JTA BBA
COMBUSTIVEL



11365 NA
JTA BBA OLEO



48441 NA
JTA TUBO OLEO



10537 NA
JTA BASE CARB



61535 NA
JTA SAÍDA AGUA
TERMOSTATO



11367 NA
JTA BBA AGUA



11368 NA
JTA DISTRIBUIÇÃO



12016 CB
JTA CARTER

XXXXX-KP
KIT PARAFUSOS DO CABEÇOTE

12006-KTRT
KIT DE RETENORES DO MOTOR

RET VALVULAS



1250191

RET GIRAB. DIANT
85,7X100,4X5,5



1151191

RET GIRAB TRAS. RET POLIA
85,7X102,6X9,7- 44,4X60,7X11



1150191



1152191

3.9 16V 4C AGRALE - MA12E / MA12SB: 05/09

3.9 16V 4C FORD-CARGO C: 915/1317E/1517E/1717E/815E-F250: CC XL / CD XLT 4X4 / RC XL / CS XLT 4X4: 04/19

3.9 16V 4C VW-8150:E/EOD/ODC-9150: E OD/ODC:03/12-DELIVERY: 10/11-WORKER: 9150 ELECT ATÉ15170E:03/11

MTR: INTERACT 4-ISBe 4 DSL TURBO INJEÇÃO DIRETA ELETRONICO

60407-JGCB	JG JTA MTR S/ CAB	60407-JGRS	JG RETIF MTR S/ CAB
60407-JGSC	JG JTA MTR C/ CAB DE FIBRA	60407-JGRV	JG RETIF MTR C/ CAB DE FIBRA
60407-JGML	JG JTA MTR C/ CAB DE CHAPA	60407-JGRM	JG RETIF MTR C/ CAB DE CHAPA
60407-JRSC	JG JTA MTR C/ CAB DE FIBRA E C/ RET	60407-JRRV	JG RETIF MTR C/ CAB DE FIBRA E RET
60407-JRML	JG JTA MTR C/ CAB DE CHAPA E C/ RET	60407-JRRM	JG RETIF MTR C/ CAB DE CHAPA E RET



OPCIONAL
 60401 MLS-1M - 1,10 MM - CIL. 107 MM
 60401 MLS-2M - 1,15 MM - CIL. 107 MM
 60401 MLS-3M - 1,25 MM - CIL. 107 MM

JUNTA CABEÇOTE



60107 KTBO SUP - KIT BORRACHAS MOTOR



60426 BO
JUNTA TAMPA VALVULAS



60447 JGBO
JOGO VEDADORES PARAFUSO TV

60426 KTBO
KIT JUNTAS TAMPA VALVULAS



60425 BO
JUNTA TAMPA BALANCEIROS



60021 FF (1PÇ) - JUNTA COLETOR ESCAPE



60019 NA
JUNTA COLETOR ADMISSÃO







48175 CV 59376 NA 48373 CV
60089 CV - JOGO JUNTA TURBINA

JG JTA RETIFICAÇÃO

<table border="1"> <thead> <tr> <th>Medidas</th> <th>Qt.</th> </tr> </thead> <tbody> <tr><td>2035</td><td>1</td></tr> <tr><td>2226</td><td>1</td></tr> <tr><td>7748</td><td>1</td></tr> <tr><td>2120</td><td>1</td></tr> <tr><td>2118</td><td>1</td></tr> <tr><td>2212</td><td>2</td></tr> <tr><td>2116</td><td>1</td></tr> <tr><td>7091</td><td>1</td></tr> <tr><td>2115</td><td>1</td></tr> <tr><td>2017</td><td>1</td></tr> <tr><td>2114</td><td>2</td></tr> <tr><td>7056</td><td>1</td></tr> <tr><td>2112</td><td>1</td></tr> <tr><td>7496</td><td>1</td></tr> <tr><td>7503</td><td>1</td></tr> <tr><td>7208</td><td>1</td></tr> <tr><td>7907</td><td>42</td></tr> <tr><td>7385</td><td>1</td></tr> </tbody> </table>	Medidas	Qt.	2035	1	2226	1	7748	1	2120	1	2118	1	2212	2	2116	1	7091	1	2115	1	2017	1	2114	2	7056	1	2112	1	7496	1	7503	1	7208	1	7907	42	7385	1	 <p>60140 NA JUNTA TUBO SUCÇÃO BOMBA DE ÓLEO</p>	 <p>60107 KTBO 01 INF KIT BORRACHAS MOTOR</p>	 <p>60031 OR 60054 OR 60060 KTOR - KIT JUNTAS RESFRIADOR ÓLEO</p>
Medidas	Qt.																																								
2035	1																																								
2226	1																																								
7748	1																																								
2120	1																																								
2118	1																																								
2212	2																																								
2116	1																																								
7091	1																																								
2115	1																																								
2017	1																																								
2114	2																																								
7056	1																																								
2112	1																																								
7496	1																																								
7503	1																																								
7208	1																																								
7907	42																																								
7385	1																																								
<p>60407 KTBO INF- KIT DE BORRACHAS DO MOTOR</p>	 <p>60035 PAK JUNTA BOMBA HIDRÁULICA</p>	 <p>60415 BO JUNTA DO CARTER</p>	 <p>60916 NA JUNTA DO CARTER</p>																																						

60407-KP
KIT PARAFUSOS DO CABEÇOTE
 12.00X1.75X130.00 (X8)
 12.00X1.75X150.00 (X10)

60407-KTRT
KIT DE RETENORES DO MOTOR

<p>RET VALVULAS</p> <p>(9,2x7x15,2)</p>  <p>(130x155x12)</p> 	<p>RET DIANT. VIRABREQUIN</p> <p>(70x100x12,5)</p>  <p>(130x150x12/13)</p> 
---	---

4.0 12V V6 - RANGER / EXPLORER: 95/

MTR: 244 - GAS

11906-JGCB JG JTA MTR S/ CAB

11906-JGSC JG JTA MTR C/ CAB DE FIBRA

11906-JRSC JG JTA MTR C/ CAB DE FIBRA E C/ RET

11906-JGRS JG RETIF MTR S/ CAB

11906-JGRV JG RETIF MTR C/ CAB DE FIBRA

11906-JRRV JG RETIF MTR C/ CAB DE FIBRA E RET

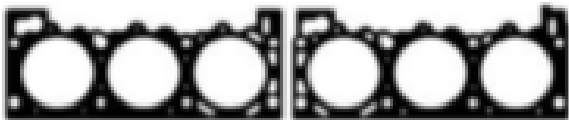

11904/5 SC - 1,4 MM - CIL. 102 MM

"OPCIONAL"

11904 KT2 - 2,0 MM - CIL. 102 MM

11905 KT3 - 3,0 MM - CIL. 102 MM

11904 KT2 - 2,0 MM - CIL. 102 MM

11905 KT3 - 3,0 MM - CIL. 102 MM

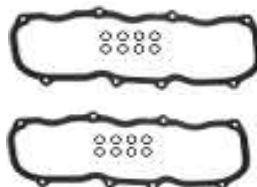

11926 CBLT

KIT JTA TAMPA VÁLVULAS
C/ LIMITADORES



11925 PAK

JTA CAPA ADMISSÃO



11933 NA

JTA CANO
D' AGUA

JTA CABEÇOTE



12022 NA (1 PÇ)

JTA COLETOR ADMISSÃO
(FLAUTA)

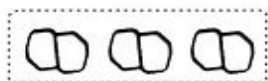

12023 JGBO

JG JTA ADMISSÃO (INJEÇÃO)

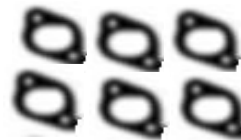

11923 PAK (1PÇ)

JTA COLETOR ESCAPE

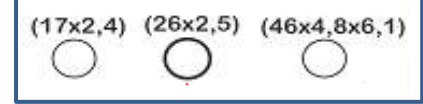

11906 KTBO - KIT VEDADORES MOTOR

JG JTA RETIFICAÇÃO



11928 NA

JTA DISTRIBUIÇÃO



11943 NA

JTA SUCÇÃO ÓLEO

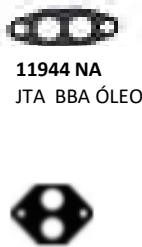

11944 NA

JTA BBA ÓLEO



11071 NA

JTA ENTRADA ÓLEO



11942 NA

JTA ENTRADA ÓLEO

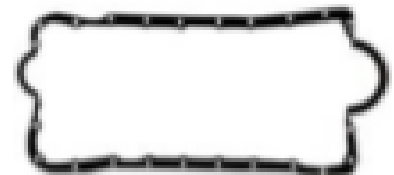

11917 CBBO

JTA CARTER

XXXXX-KP
KIT PARAFUSOS DO CABEÇOTE

11906-KTRT
KIT DE RETENORES DO MOTOR

RET VALVULAS-08X12X11



1222396

RETENTOR DIANT GIRABREQUIM-RET GIRABREQUIM TRASEIRO

42X56X07

60,3X76,2X11,1



1130053



1130153

4.0 12V V6 - RANGER / EXPLORER: 90/94
MTR: 244 - GAS

11907-JGCB JG JTA MTR S/ CAB

11907-JGSC JG JTA MTR C/ CAB DE FIBRA

11907-JRSC JG JTA MTR C/ CAB DE FIBRA E C/ RET

11907-JGRS JG RETIF MTR S/ CAB

11907-JGRV JG RETIF MTR C/ CAB DE FIBRA

11907-JRRV JG RETIF MTR C/ CAB DE FIBRA E RET

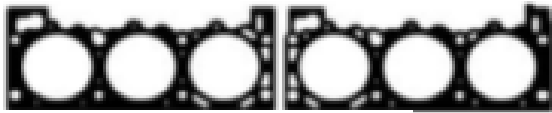

11904/5 SC - 1,4 MM - CIL. 102 MM

"OPCIONAL"

11904 KT2 - 2,0 MM - CIL. 102 MM

11905 KT3 - 3,0 MM - CIL. 102 MM

11904 KT2 - 2,0 MM - CIL. 102 MM

11905 KT3 - 3,0 MM - CIL. 102 MM

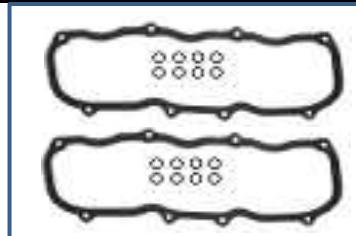

11926 CBLT

KIT JTA TAMPA VÁLVULAS C/
LIMITADORES

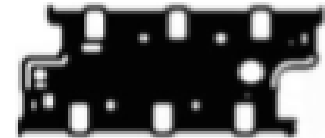

11920 PAK

JTA CAPA ADMISSÃO

JTA CABEÇOTE



12022 NA (1PÇ)

JTA COLETOR ADMISSÃO (FLAUTA)



11923 PAK (1PÇ)

JTA COLETOR ESCAPE

(17x2,4) (26x2,5) (46x4,8x6,1)



11906 KTBO - KIT VEDADORES MOTTOR

JG JTA RETIFICAÇÃO



11933 NA

JTA ENTRADA ÓLEO



11943 NA

JTA SUCÇÃO
ÓLEO



11071 NA

JTA ENTRADA ÓLEO



11928 NA

JTA DISTRIBUIÇÃO



11944 NA

JTA BBA ÓLEO



11932 NA

JTA BBA D'AGUA

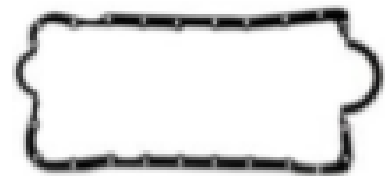

11918 BO

JUNTA CARTER

XXXXX-KP

KIT PARAFUSOS DO CABEÇOTE

11906-KTRT

KIT DE RETENORES DO MOTOR

RET VALVULAS-08X12X11



1222396

RETENTOR DIANT GIRABREQUIM-RET GIRABREQUIM TRASEIRO

42X56X07

60,3X76,2X11,1



1130053



1130153

4.2 18V 6C - GM - SILVERADO 3500 / GMC 6150 : 97/00

4.2 18V 6C - FORD - F250 98/05

4.2 18V 6C - VOLARE - VOLARE

MTR: SPRINT 6.07TCA TURBO DIESEL - MECÂNICO / ELETRÔNICO

71005-JGCB JG JTA MTR S/ CAB

71005-JGSC JG JTA MTR C/ CAB DE FIBRA

71005-JRSC JG JTA MTR C/ CAB DE FIBRA E C/ RET

71005-JGRS JG RETIF MTR S/ CAB

71005-JGRV JG RETIF MTR C/ CAB DE FIBRA

71005-JRRV JG RETIF MTR C/ CAB DE FIBRA E RET



"OPCIONAL"

71003-1M-SC - 1,4 MM - CIL. 96 MM

71002-KT - 2,4 MM - CIL. 96 MM

JTA CABEÇOTE



71422 CB

JTA COLETOR ADMISSÃO



71082 NA

JTA BASE TERMOSTATO



80033 NA

JTA RETORNO ÓLEO



71022 F

JTA ESCAPE

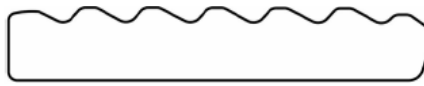

71086 BO - JTA DE TAMPA DE VÁLVULAS



71079 JGBO - VEDADOR DA TAMPA DE VÁLVULAS



71321 F (1PÇ)

JTA COLETOR ESCAPE

71086 KTBO - KIT DE JTAS DE TAMPA DE VÁLVULAS

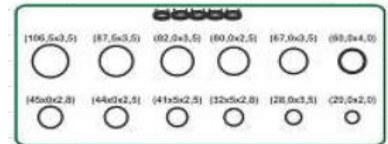

71005 KTBO - KIT VEDADORES MOTOR

JG JTA RETIFICAÇÃO



71077 NA

JTA RAD ÓLEO



71079 PAK

JTA RAD ÓLEO



70369 NA

JTA BBA INJ



71036 NA

JTA RESFRIADOR
ÓLEO 4.08



71033 NA

JTA ADMISSÃO
PEQ.



71080 NA

JTA BBA OLEO

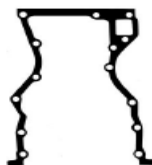

71078 NA

JTA DISTRIBUIÇÃO



71097 NA

JTA CARTER

71005-KP

KIT PARAFUSOS DO CABEÇOTE

14.00X2.00X165.00 (X14)

71005-KTRT

KIT DE RETENORES DO MOTOR

RET VALVULAS-07X11X10



1250058

RET VIRABREQUIM DIANT

64X80X09



1150058

RET VIRABREQUIM TRAS.

90,5X111X10



1150158

4.2 24V 4C - F250 98/03

MTR: 4.2L OHV EFI - GAS

12406-JGCB	JG JTA MTR S/ CAB	12406-JGRS	JG RETIF MTR S/ CAB
12406-JGSC	JG JTA MTR C/ CAB DE FIBRA	12406-JGRV	JG RETIF MTR C/ CAB DE FIBRA
12406-JGML	JG JTA MTR C/ CAB DE CHAPA	12406-JGRM	JG RETIF MTR C/ CAB DE CHAPA
12406-JRSC	JG JTA MTR C/ CAB DE FIBRA E C/ RET	12406-JRRV	JG RETIF MTR C/ CAB DE FIBRA E RET
12406-JRML	JG JTA MTR C/ CAB DE CHAPA E C/ RET	12406-JRRM	JG RETIF MTR C/ CAB DE CHAPA E RET



12403 MLS - 0,7 MM
JUNTA CABEÇOTE

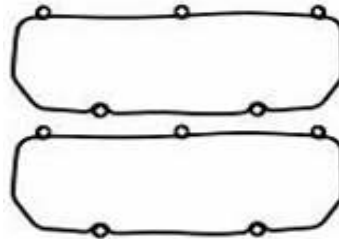

12426 JGBO
JUNTA TAMPA VALVULAS



12420 NA
JUNTA COLETOR ADMISSÃO



47223 F
JUNTA DO COLETOR DE ESCAPE

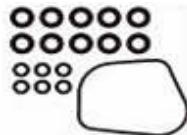

47406 KTBO - KIT BORRACHAS MOTOR



12420 NA
JUNTA COLETOR ADMISSÃO INTERNA

JG JTA RETIFICAÇÃO



12434 NA
JUNTA



12430 NA
JUNTA BOMBA D'AGUA



11071 NA
JUNTA



12429 NA
JUNTA TAMPA DISTRIBUIÇÃO E BOMBA DE ÓLEO



80033 NA
JUNTA



12433 NA
JUNTA



12435 NA
JUNTA

XXXXX-KP
KIT PARAFUSOS DO CABEÇOTE

12406-KTRT
KIT DE RETENORES DO MOTOR
RET HASTE VALVULAS RET DIANT. VIRABREQUIM



RET DIANT VIRABREQUIM



RET TRAS VIRABREQUIM



4.3 8V 4C GM - 7000 / 7500 / 8000 / 8500

4.3 8V 4C FORD - F1000 4X4 96/98 - F4000 96/98

4.3 8V 4C VW -12140T 92/00-13150 00/05-7100 87/02-7100/20:02/05-8100/20 97/05-8140/50-8120/50 OC/OD 03/05

4.3 8V 4C AGRALE - 6000 / 7000 / 8500 / 9500 / A8 VOLARE / FURGOVAN 8000

MTR: X10 / X10T / X10TCA - EURO I II III - 4.10 / 4.10T / 4.10 TCA - DIESEL

71104-JGCB JG JTA MTR S/ CAB

71104-JGSC JG JTA MTR C/ CAB DE FIBRA

71104-JGML JG JTA MTR C/ CAB DE CHAPA

71104-JRSC JG JTA MTR C/ CAB DE FIBRA E C/ RET

71104-JRML JG JTA MTR C/ CAB DE CHAPA E C/ RET

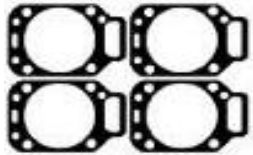

71102 SC - 1,50 MM CIL. 113 MM
71102 MLS- 1,50 MM CIL. 113 MM



71826 BO
JUNTA TAMPA VÁLVULAS



71131 PAK
JUNTA COL.
ADMISSÃO



71121 FS
JUNTA COL.
ESCAPE



71144 PAK
JUNTA COL.
ESCAPE

71137 FA
JUNTA
ESCAPE



71376 PAK
JUNTA
TURBINA



71383 CV
JUNTA
TURBINA



71373 CV
JUNTA
TURBINA



71132 PAK
JUNTA
ADMISSÃO



71133 PAK
JUNTA CURVA
ADMISSÃO



71035 NA
JUNTA INJETORA



71123 NA
JUNTA
RESPIRO



71637
JUNTA
FLANGE



71129 NA
JUNTA BBA
D'AGUA



71139 NA
JUNTA



71141 NA
JUNTA CANO



71444 NA
JUNTA
FLANGE BBA



71623 FA
JUNTA ESCAPE



71930 NA
JUNTA



59376 NA
JUNTA
RETORNO
TURBINA



71266 NA
JUNTA
RETORNO
TURBINA



71154 BO
ANEL CAMISA MOTOR



71004 KTBO
KIT BORRACHAS MOTOR

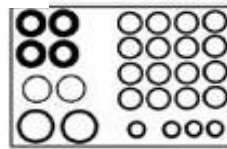

71004 KTAR
KIT ARRUELAS MOTOR

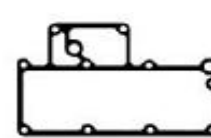

71534 NA
JUNTA FILTRO ÓLEO



71767 NA
JUNTA FILTRO



71135 PV
JUNTA DISTRIBUIÇÃO



71131 PV
JUNTA DISTRIBUIÇÃO



71130 PV
JUNTA DISTRIBUIÇÃO



71916 NA
JUNTA CARTER

XXXXX-KP

KIT PARAFUSOS DO CABEÇOTE

71004-KTRT

KIT DE RETENORES DO MOTOR

RET VALVULAS
(8,7x13,5x11)

1282927

RET DIANT. VIRABREQUIM

(78x100x12)

1182871

RET TRAS. VIRABREQUIM

(130x160x12)

1182872

4.8 16V V8 - F100 / F350 / F600 / GALAXIE: 55/76

MTR: 292 - GAS

11107-JGCB JG JTA MTR S/ CAB

11107-JGSC JG JTA MTR C/ CAB DE FIBRA

11107-JGML JG JTA MTR C/ CAB DE FIBRA

11107-JGRS JG RETIF MTR S/ CAB

11107-JGRV JG RETIF MTR C/ CAB DE FIBRA

11107-JGRM JG RETIF MTR C/ CAB DE FIBRA

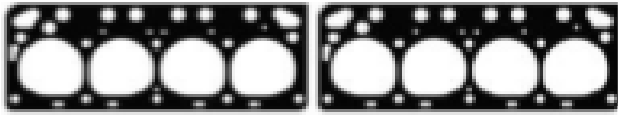

11020 SC
JTA CABEÇOTE

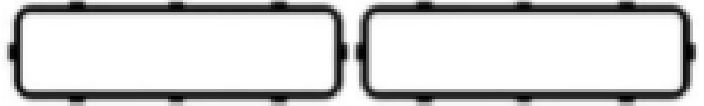

11863 CB - JUNTA DA TAMPA DE VÁLVULAS



11729 PAK
JTA COLETOR ESCAPE



11999 NA
JTA BASE CARBURADOR



11864 CB
JTA CENTRAL VÁLVULAS

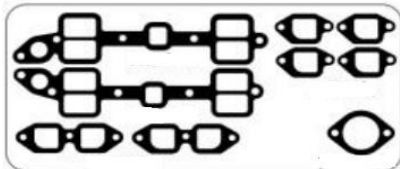

11935 PAK
JG JTA COLETOR ESCAPE



11903 GV
JTA TERMOSTATO



11914 BO
VEDADOR HASTE VÁLVULAS



11911 BO
VEDADOR PARAFUSO TAMPA VÁLVULAS

JG JTA RETIFICAÇÃO

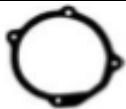

11939 NA
JTA BBA AGUA



11570 GV
JTA BBA ÓLEO AO BLOCO



11966 GV
JTA BBA COMBUSTÍVEL



10296 NA
JTA BBA COMBUSTÍVEL



11907 NA
JTA TUBO TERMOSTATO



11865 CB
JTA BASE FILTRO



261420
ANEL BUJÃO CARTER
14,3 X 20 X 1,5 MM



11660 CB
JTA VENTILADOR CARTER



11950-A
GAXETA MANCAL



11951-A
GAXETA LAT MANCAL

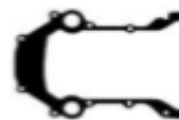

11898 NA
JTA DISTRIBUIÇÃO



11860 CB
JTA CARTER

4.9 12V 6C - F1000 / F100 / F150 : 91/
MTR: 300 CID - GAS

12606-JGCB	JG JTA MTR S/ CAB	12606-JGRS	JG RETIF MTR S/ CAB
12606-JGSC	JG JTA MTR C/ CAB DE FIBRA	12606-JGRV	JG RETIF MTR C/ CAB DE FIBRA
12606-JRSC	JG JTA MTR C/ CAB DE FIBRA E C/ RET	12606-JRRV	JG RETIF MTR C/ CAB DE FIBRA E RET

 <p>12602 SC JTA CABEÇOTE</p>	 <p>12626 CB JTA DA TAMPA DE VÁLVULAS</p>
 <p>12621 PAK</p>	 <p>12627 CB JTA TAMPA VÁLVULAS LATERAL</p>
 <p>12622 NA JTA COLETOR ADMISSÃO</p>	<p>JG JTA RETIFICAÇÃO</p>

 <p>12630 NA JTA BBA D'AGUA</p>	 <p>12629 NA JTA DISTRIBUIÇÃO</p>	 <p>12644 NA JTA</p>	 <p>12616 BO JTA CARTER</p>
 <p>12633 NA JTA</p>	 <p>12634 NA JTA</p>	 <p>12636 NA JTA</p>	 <p>12643 NA JTA</p>

XXXXX-KP
KIT PARAFUSOS DO CABEÇOTE

12606-KTRT
KIT DE RETENTORES DO MOTOR

<p>RET VALVULAS</p> 	<p>RET COMANDO-34X48X07</p>
<p>RET VIRABREQUIM DIANT. 36,5X50,5X07</p> 	<p>RET VIRABREQUIM TRAS. 83X100X09</p> 

5.0 16V V8 - MAVERICK / GALAXIE / LANDAU : 76/81

MTR: 302 - GAS

11308-JGCB JG JTA MTR S/ CAB

11308-JGSC JG JTA MTR C/ CAB DE FIBRA

11308-JGRS JG RETIF MTR S/ CAB

11308-JGRV JG RETIF MTR C/ CAB DE FIBRA



11302 SC
JTA CABEÇOTE

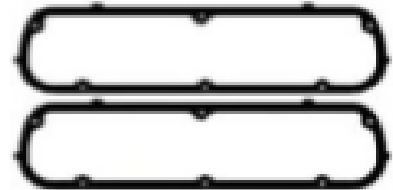

11726 CB
JTA TAMPA VÁLVULAS



11719 PAK
JTA COLETOR ESCAPE

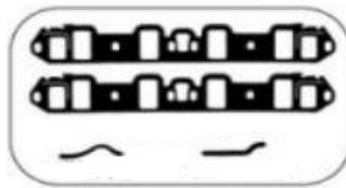

11721 PAK
JTA COLETOR ADMISSÃO



11736 BO
VEDADOR HASTE VÁLVULAS

JG JTA RETIFICAÇÃO



11727 NA
JTA DISTRIBUIÇÃO



11728 NA
JTA BBA D AGUA



11730 NA
JTA BBA
AGUINTERNA



11731 NA
JTA BBA D
AGUA
INTERNA



10296 NA
JTA BBA
COMBUSTIVEL



11720 NA
JTA
TERMOSTATO
IMPORTADO



11746 NA
JTA TUBO
ÓLEO



11738 NA
JTA



11723 PP
JTA BBA ÓLEO



11732 NA
JTA VÁLVULA
TEMOSTATICA



11379 A
GAXETA
MANCAL

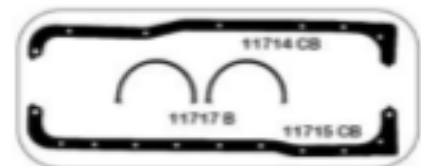

11716 CB
JTA CARTER

XXXXX-KP
KIT PARAFUSOS DO CABEÇOTE

5.8 12V 6C GM - D60 70/84

5.8 12V 6C GMC - D60 64/80 - D65 65/84 - D70 64/89

5.8 12V 6C FORD - D60 64/80 - D65 65/84 - D70 64/89 -

5.8 12V 6C DODGE - P700 70/77 - D750 77/78 - P900 73/81

MTR: 6357V INDIRETA / DIRETA - DIESEL

70906-JGCB	JG JTA MTR S/ CAB	70906-JGRS	JG RETIF MTR S/ CAB
70906-JGSC	JG JTA MTR C/ CAB DE FIBRA	70906-JGRV	JG RETIF MTR C/ CAB DE FIBRA
70906-JRSC	JG JTA MTR C/ CAB DE FIBRA E C/ RET	70906-JRRV	JG RETIF MTR C/ CAB DE FIBRA E RET



70901 SC 1,5 MM CIL. 105 MM
JUNTA CABEÇOTE



70826 CB
JUNTA TAMPA VÁLVULAS



70821 PAK
JUNTA COLETOR ESCAPE



70831 NA
JUNTA COLETOR ADMISSÃO



70827 NA
JUNTA CAMERA D'AGUA



70845 NA
JUNTA ADMISSÃO AR



70846 PAK
JUNTA ESCAPE



70863 CI
GAXETA ESCAPE



70833 NA
JUNTA TRAS. MANCAL



70847 NA
JUNTA TRAS. CABEÇOTE



70967 NA
JUNTA TERMOSTATO



70763 NA
JUNTA BBA ÓLEO



70936 NA
JUNTA CABO BBA ÓLEO



70835 NA
JUNTA



70939 NA
JUNTA ACIONADOR TACOMETRO



70937 NA
JUNTA VENTILAÇÃO CARTER



70929 CB
JUNTA TAMPA INSPEÇÃO



70864 NA
JUNTA BBA D'AGUA



70941 NA
JUNTA EXAUSTOR



70844 NA
JUNTA BBA COMBÚSTIVEL



70960 NA
JUNTA BBA ALIMENTAÇÃO



70035 NA
JUNTA BBA INJETORA



70964 NA
JUNTA BBA ÓLEO

	MEDIDAS	Quant.
17.38.01.1	AR 10,3 x 21,3 x 2,0mm	8
	AR 14,5 x 21 x 1,5mm	14
	AR 40,1 x 46,8 x 0,8mm	8
	AR 19,5 x 27 x 1,5 mm	1
	AR 10,5 x 15,5 x 1 mm	14
	AR 14,5 x 21 x 1,5 mm	8
	AR 14,5 x 21 x 1,5 mm	14



70928 NA
JUNTA DISTRIBUIÇÃO



70843 NA
JUNTA MANCAL TRASEIRO



70019 A
GAXETA MANCAL



70916 CB
JUNTA CARTER

70906 KTAR
KIT ARRUELAS MOTOR

XXXXX-KP

KIT PARAFUSOS DO CABEÇOTE

70906-KTRT

KIT DE RETENORES DO MOTOR

RET VALVULAS
(9,5x14,3x14,3)



1270030

RET DIANT. VIRABREQUIN
(50x70x9,5)



1170586

5.9 12V 6C AGRALE - MA 8,5 SUPER 96/05

5.9 12V 6C FORD - CARGO C: 1417 A TÊ 2421: 92/06 - F12000/F14000/F16000: 98/05

5.9 12V 6C VW - 12170 BT/13170/13190/14170BT/15170/15190/15200/17210/23210: 93/05

MTR: 6 BT DSL TURBO INJEÇÃO DIRETA

60106-JGCB	JG JTA MTR S/ CAB	60106-JGRS	JG RETIF MTR S/ CAB
60106-JGSC	JG JTA MTR C/ CAB DE FIBRA	60106-JGRV	JG RETIF MTR C/ CAB DE FIBRA
60106-JGML	JG JTA MTR C/ CAB DE CHAPA	60106-JGRM	JG RETIF MTR C/ CAB DE CHAPA
60106-JRSC	JG JTA MTR C/ CAB DE FIBRA E C/ RET	60106-JRRV	JG RETIF MTR C/ CAB DE FIBRA E RET
60106-JRML	JG JTA MTR C/ CAB DE CHAPA E C/ RET	60106-JRRM	JG RETIF MTR C/ CAB DE CHAPA E RET



60406 SC - 1,7 MM - CIL. 106,5 MM
JUNTA CABEÇOTE

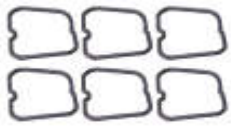

60926 BO
JUNTA TAMPA VALVULAS



60920 F
JUNTA COLETOR ESCAPE



48373 CV
JUNTA TURBINA



60527 BO
JUNTA TAMPA LATERAL VÁLVULAS

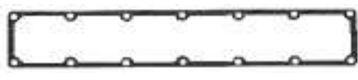

60838 NA
JUNTA COLETOR ADMISSÃO



60854 NA
JUNTA COLETOR ADMISSÃO

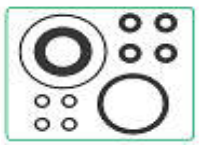

60106 KTBO
KIT DE BORRACHAS MOTOR
JG JTA RETIFICAÇÃO

MEDIDAS		Qt.
AR 18,0 x 24,0 x 1,5	CU	1
AR 22,0 x 26,7 x 1,5	AL	1
AR 22,0 x 26,7 x 1,5	CU	1
AR 22,5 x 26,7 x 1,5	CU	2
AR 6,0 x 10,0 x 1,0	CU	6
AR 7,3 x 15,2 x 1,0	CU	6
AR 7,3 x 15,2 x 2,0	CU	6
AR 8,5 x 20,0 x 2,0	CU	6
AR 8,5 x 16,0 x 1,5	CU	6



60847 NA
JUNTA BOMBA DE ÓLEO



48377 NA
JUNTA DO ÓLEO TURBINA



60845 NA
JUNTA BBA ÓLEO



60671 OR **60472 OR**

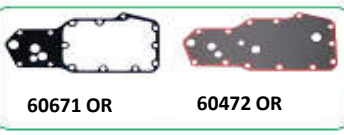

66470 KTOR
KIT JUNTAS REFRIGERAÇÃO DO ÓLEO

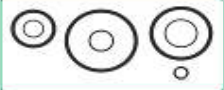

47435 NA
JUNTA



60844 NA
JUNTA BBA TRANSFERENCIA



60835 NA
JUNTA BOMBA INJETORA



60106 KTAR
KIT ARRUELAS MOTOR



60853 PAK
JUNTA COMPRESSOR



60834 NA
JUNTA



50836 NA
JUNTA BBA HIDRÁULICA



60849 NA
JUNTA CAIXA DISTRIBUIÇÃO



60846 NA
JUNTA DA TAMPA



60453 CV
JUNTA DA TURBINA

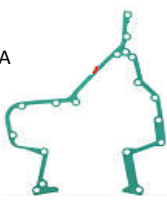

60828 NA
JUNTA TAMPA DISTRIBUIÇÃO INTERNA

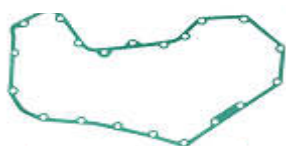

60827 NA
JUNTA TAMPA DISTRIBUIÇÃO C/ BBA ROTATIVA

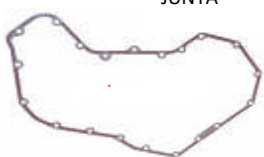

60827 NA
JUNTA TAMPA DISTRIBUIÇÃO C/ BBA EM LINHA



60917 PV
JUNTA CARTER

XXXXX-KP
KIT PARAFUSOS DO CABEÇOTE

60106-KTRT
KIT DE RETENORES DO MOTOR
RET HASTE VALVULAS

(7,9x14x12,6)



1290010042

(63x79,6x8)



119011004

(130x150x12/13)



119021004

5.9 12V 6C GM - D60 81/89

5.9 12V 6C GMC - D70 64/84 - D80 (853/883) 81/84 - D90 (953/983/993) 81/84

5.9 12V 6C FORD - F400 / F600 / F700

MTR: 6358 INJEÇÃO DIRETA - DIESEL

70706-JGCB JG JTA MTR S/ CAB

70706-JGSC JG JTA MTR C/ CAB DE FIBRA

70706-JRSC JG JTA MTR C/ CAB DE FIBRA E C/ RET

70706-JGRS JG RETIF MTR S/ CAB

70706-JGRV JG RETIF MTR C/ CAB DE FIBRA

70706-JRRV JG RETIF MTR C/ CAB DE FIBRA E RET



70701 SC 1,5 MM CIL 105 MM
JUNTA CABEÇOTE



70726 CB
JUNTA TAMPA VÁLVULAS

70846 PAK
JUNTA ESCAPE



70835 NA
JUNTA CONEXÃO



70731 NA
JUNTA CONEXÃO D'ÁGUA



70736 NA
JUNTA TRAS. D'ÁGUA



70730 NA
JUNTA TERMOSTATO



70864 NA
JUNTA BBA D'ÁGUA



70827 NA
JUNTA CAMERA D'ÁGUA



70720 PAK
JOGO JUNTA COLETOR ESCAPE E ADMISSÃO



70937 NA
JUNTA



70964 NA
JUNTA



70942 NA
JUNTA



70737 NA
JUNTA LATERAL BBA D'ÁGUA



70936 NA
JUNTA



70844 NA
JUNTA SUP. BBA ÓLEO



70741 NA
JUNTA



70763 NA
JUNTA



70734 NA
JUNTA RESPIRO ÓLEO



70744 NA
JUNTA COMPRESSOR



70035 NA
JUNTA BBA INJETORA



70939 NA
JUNTA TAMPA COMANDO



70234 PP
JUNTA BBA ÓLEO



70728 NA
JUNTA DISTRIBUIÇÃO



70732 NA
JUNTA MANCAL TRASEIRO



70929 CB
JUNTA TAMPA INSPEÇÃO



70916 CB
JUNTA CARTER

XXXXX-KP

KIT PARAFUSOS DO CABEÇOTE

70706-KTRT

KIT DE RETENORES DO MOTOR

RET VALVULAS
(9,9x14,3x13,1)



1272590

RET DIANT. VIRABREQUIM

RET DIANT. VIRABREQUIM

(60,4x79,35x9,3)



1171050

RET TRAS. VIRABREQUIM

(133,35x158,75x13)



1171972

5.9 24V 6C DODGE - RAM 2500/ AUT SLT TROPIVA: 01/10

5.9 24V 6C FORD - CARGO: 1722E/C2628CN/C2622E/C2628E/C2422/C2428E: 06/11

5.9 24V 6C IVECO - EUROCARGO: 170E22 ATÉ IVECO BUS 170E22: 05/08-TECTOR 170E28T ATÉ 240E28S: 08/21

5.9 24V 6C VW - CONSTELLATION: 24250/17250: 05/11-WORKER: 17250/23250E/24250E: 03/11

MTR: ISB 6BT / INTERACT 6-ISBe 6 / F4AEO681D: DSL TURBO INJ DIR ELETRONICO

60107-JGCB JG JTA MTR S/ CAB

60107-JGML JG JTA MTR C/ CAB DE CHAPA

60107-JRML JG JTA MTR C/ CAB DE CHAPA E C/ RET

60107-JGRS JG RETIF MTR S/ CAB

60107-JGRM JG RETIF MTR C/ CAB DE CHAPA

60107-JRRM JG RETIF MTR C/ CAB DE CHAPA E RET



"OPCIONAL"

60402 MLS-1M - 1,10 MM - CIL. 107 MM
60402 MLS-2M - 1,15 MM - CIL. 107 MM
60402 MLS-3M - 1,25 MM - CIL. 107 MM

JUNTA DO CABEÇOTE

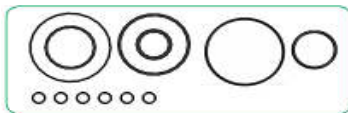

60107 KTBO SUP - KIT DE BORRACHAS DO MOTOR

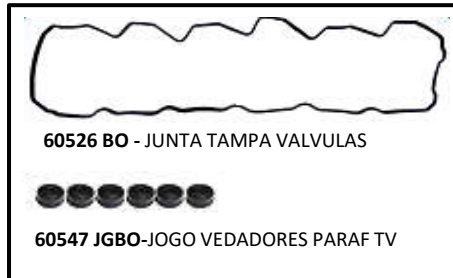

60526 BO - JUNTA TAMPA VALVULAS



60528 BO - JUNTA TAMPA BALANCEIROS



60021 FF (1PÇ)
JUNTA COLETOR ESCAPE



60020 NA
JUNTA COLETOR ADMISSÃO



60089 CV - JOGO JUNTA TURBINA

JG JTA RETIFICAÇÃO

Medidas	Qt.
2036	1
2226	1
7748	1
2120	1
2118	1
2212	2
2110	1
7091	1
2115	1
2017	1
2114	2
7056	1
2112	1
7496	1
7503	1
7208	1
7907	12
7386	1

Medidas	Qt.
AR 15 x 7,8 x 1,5	4
18401009-10	2
AR 24 x 13,5 x 2,4	1

60107 KTAR
- KIT DE ARRUELAS DO MOTOR

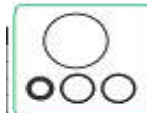

60107 KTBO 01 INF
KIT BORRACHAS MOTOR

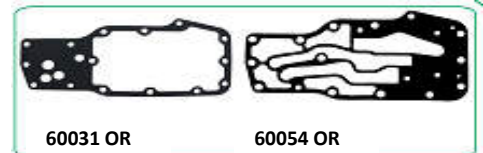

60031 OR 60054 OR
60060 KTOR
KIT JUNTAS RESFRIADOR ÓLEO

60107 KTBO
INF- KIT DE
BORRACHAS
DO MOTOR

60140 NA
JUNTA TUBO
SUCÇÃO BOMBA DE
ÓLEO

60035 PAK
JUNTA BOMBA
HIDRÁULICA



60915 BO
JUNTA CARTER



60914 NA
JUNTA CARTER

60107-KP
KIT PARAFUSOS DO CABEÇOTE
12.00X1.75X130.00 (X12)
12.00X1.75X150.00 (X14)

60107-KTRT
KIT DE RETENORES DO MOTOR
RET HASTE VALVULAS



129001008

(130x155x12,5)



119021008

(70x100x12,5)



119011008

(130x150x12/13)



119021004

6.5 12V 6C-AGRALE-13000 E-MEC 07/11-MT15 //**FORD**-B1618/B1621/B12000/F12000/F12000L/F14000: 93/98

6.5 12V 6C-IVECO - EUROCARGO 170-E21 04/06 //VW-12-180/13-180/1

6.5 12V 6C-VW - 12-180/13-180/14-150/14-180/14-200/15-180/16-180 CO/16210 CO/17-210/17-210 OD/

17-240 OT/23-210: 99/05 - WORKER: 15-180/15-180 CN/17-180:06/11 - 15-210 FAB MILI: 07/11 - 15-210 4X4 18/21

6.5 12V 6C-VOLVO - VM 17210 / VM 17240 / VM 23210 / VM 23240: 03/05

MTR: SERIE 10/X10-6.10 TCA DSL TURBO INJEÇÃO DIRETA - DIESEL

71105-JGCB	JG JTA MTR S/ CAB	71105-JGRS	JG RETIF MTR S/ CAB
71105-JGSC	JG JTA MTR C/ CAB DE FIBRA	71105-JGRV	JG RETIF MTR C/ CAB DE FIBRA
71105-JGML	JG JTA MTR C/ CAB DE CHAPA	71105-JGRM	JG RETIF MTR C/ CAB DE CHAPA
71105-JRSC	JG JTA MTR C/ CAB DE FIBRA E C/ RET	71105-JRRV	JG RETIF MTR C/ CAB DE FIBRA E RET
71105-JRML	JG JTA MTR C/ CAB DE CHAPA E C/ RET	71105-JRRM	JG RETIF MTR C/ CAB DE CHAPA E RET

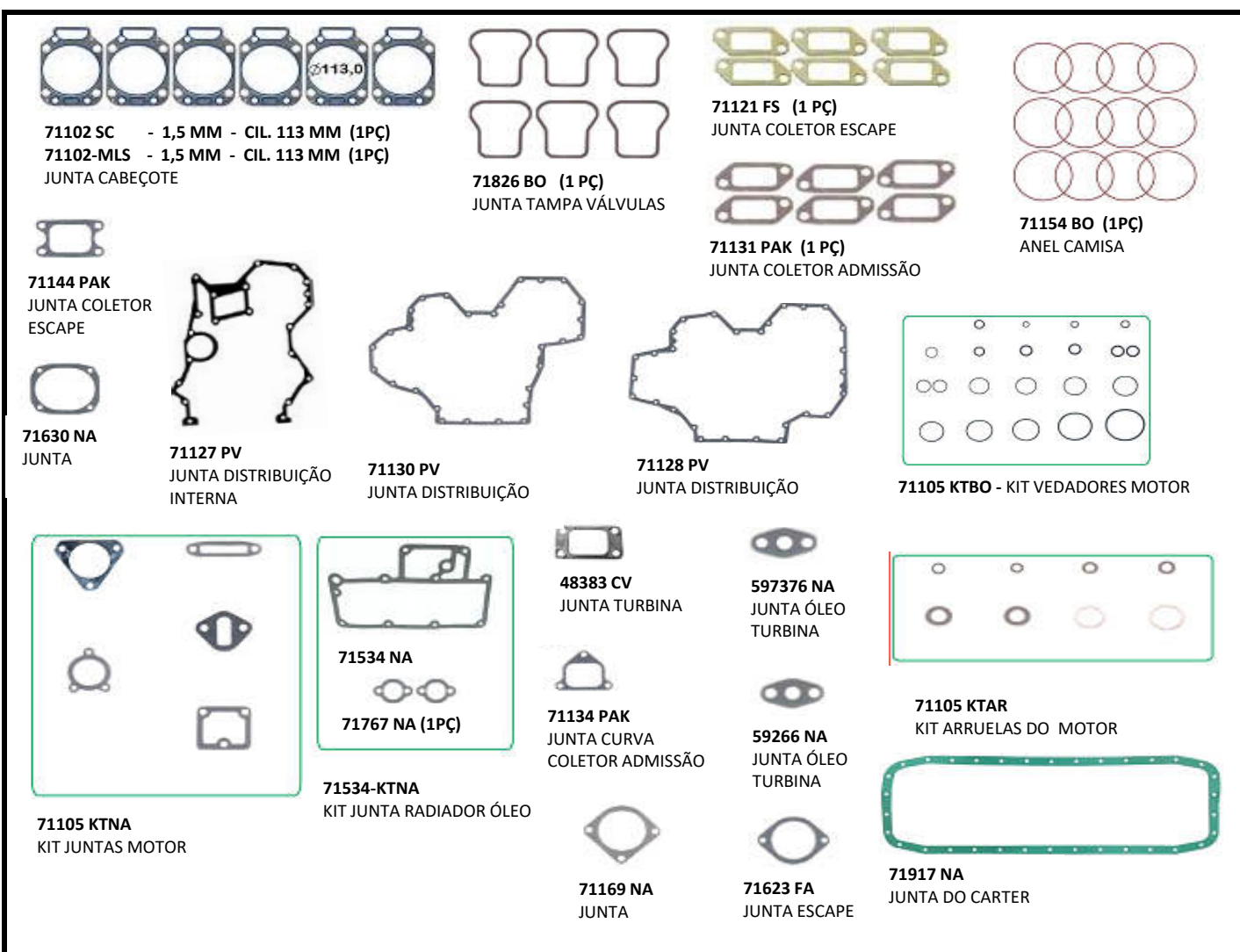

71102 SC - 1,5 MM - CIL. 113 MM (1PÇ)
71102-MLS - 1,5 MM - CIL. 113 MM (1PÇ)
 JUNTA CABEÇOTE

71826 BO (1 PÇ)
 JUNTA TAMPA VÁLVULAS

71121 FS (1 PÇ)
 JUNTA COLETOR ESCAPE

71154 BO (1PÇ)
 ANEL CAMISA

71144 PAK
 JUNTA COLETOR ESCAPE

71131 PAK (1 PÇ)
 JUNTA COLETOR ADMISSÃO

71630 NA
 JUNTA

71127 PV
 JUNTA DISTRIBUIÇÃO INTERNA

71130 PV
 JUNTA DISTRIBUIÇÃO

71128 PV
 JUNTA DISTRIBUIÇÃO

71105 KTBO - KIT VEDADORES MOTOR

48383 CV
 JUNTA TURBINA

597376 NA
 JUNTA ÓLEO TURBINA

71534 NA
71767 NA (1PÇ)

71134 PAK
 JUNTA CURVA COLETOR ADMISSÃO

59266 NA
 JUNTA ÓLEO TURBINA

71105 KTAR
 KIT ARRUELAS DO MOTOR

71105 KTNA
 KIT JUNTAS MOTOR

71534-KTNA
 KIT JUNTA RADIADOR ÓLEO

71169 NA
 JUNTA

71623 FA
 JUNTA ESCAPE

71917 NA
 JUNTA DO CARTER

XXXXX-KP
KIT PARAFUSOS DO CABEÇOTE

71105-KTRT
KIT DE RETENTORES DO MOTOR

RET VALVULAS
 (8,7x13,5x11)

 1282927

(78x100x12)

 1182871

(130x160x12)

 1182872

6.6 12V 4C - F4000

MTR: 6600

61507-JGCB	JG JTA MTR S/ CAB	61507-JGRS	JG RETIF MTR S/ CAB
61507-JGSC	JG JTA MTR C/ CAB DE FIBRA	61507-JGRV	JG RETIF MTR C/ CAB DE FIBRA
61507-JGML	JG JTA MTR C/ CAB DE CHAPA	61507-JGRM	JG RETIF MTR C/ CAB DE CHAPA
61507-JRSC	JG JTA MTR C/ CAB DE FIBRA E C/ RET	61507-JRRV	JG RETIF MTR C/ CAB DE FIBRA E RET
61507-JRML	JG JTA MTR C/ CAB DE CHAPA E C/ RET	61507-JRRM	JG RETIF MTR C/ CAB DE CHAPA E RET

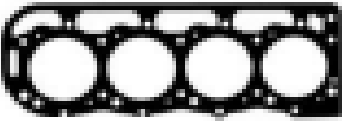

61501 SC
JUNTA CABEÇOTE



61526 CB
JUNTA TAMPA VALVULAS



61521 PAK
JUNTA COLETOR ESCAPE



61622 NA
JUNTA COLETOR ADMISSÃO



61539 CB
JUNTA



61261 FA
GAXETA ESCAPE



61535 NA
JUNTA



61542 BO
ANEL



61544 BO
ANEL



260914
ARRUELAS

JG JTA RETIFICAÇÃO



61416 CB
JUNTA CARTER



61527 NA
JUNTA DISTRIBUIÇÃO



61528 NA
JUNTA DISTRIBUIÇÃO INTERNA



61529 NA
JUNTA BOMBA D'AGUA

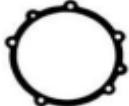

61530 NA
JUNTA



61536 NA
JUNTA



61532 NA
JUNTA



61533 NA
JUNTA



61534 NA
JUNTA



61536 NA
JUNTA



61537 NA
JUNTA



61573 PAK
JUNTA ESCAPE



61543 CB
JUNTA

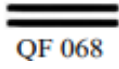

QF 068
GAXETA MANCAL



61631 NA
JUNTA MANCAL TRAS.

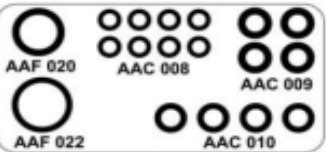

61507 KTAR - KIT ARRUELAS MOTOR

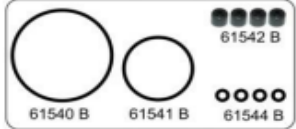

61507 KTBO - KIT BORRACHAS MOTOR

XXXXX-KP
KIT PARAFUSOS DO CABEÇOTE

61507-KTRT
KIT DE RETENORES DO MOTOR

RET DIANT VIRABREQUIM

RET TRAS VIRABREQUIM



02448 BRAG-F



02449 BRG-F

6.8-7.8 12V 6C - FORD CARGO - COLHEITADEIRA 8040 / 8055 / 7380

MTR: 6800 FASE 1 e 7800 FASE 2

61706-JGCB	JG JTA MTR S/ CAB	61706-JGRS	JG RETIF MTR S/ CAB
61706-JGSC	JG JTA MTR C/ CAB DE FIBRA	61706-JGRV	JG RETIF MTR C/ CAB DE FIBRA
61706-JGML	JG JTA MTR C/ CAB DE CHAPA	61706-JGRM	JG RETIF MTR C/ CAB DE CHAPA
61706-JRSC	JG JTA MTR C/ CAB DE FIBRA E C/ RET	61706-JRRV	JG RETIF MTR C/ CAB DE FIBRA E RET
61706-JRML	JG JTA MTR C/ CAB DE CHAPA E C/ RET	61706-JRRM	JG RETIF MTR C/ CAB DE CHAPA E RET

61601 SC
JUNTA CABEÇOTE

61626 CB
JUNTA TAMPA VALVULAS

61321 PAK
JUNTA COLETOR ESCAPE

61759 PAK
JTA

61724 NA
JUNTA COLETOR ADMISSÃO

61722 NA
JUNTA COLETOR ADMISSÃO

61723 PAK - JUNTA COLETOR ESCAPE

61727 NA
JTA DISTRIBUIÇÃO

61627 NA
JTA DISTRIBUIÇÃO

617528 NA
JTA DISTRIBUIÇÃO INTERNA

61631 CB
JTA MANCAL TRAS

61716 CB
JTA CARTER

61629 NA
JTA

61734 NA
JTA

61531 CB
JTA MANCAL

61733 NA
JTA

61734 NA
JTA

61736 NA
JTA

61537 GV
JTA

61630 CB
JTA

61729 NA
JTA

48376 NA
JTA

61730 CB
JTA

61731 NA
JTA

61732 NA
JTA

61733 NA
JTA

61735 BO
JTA

61743 CB
JTA

59265 NA
JTA

49429 CV
JTA TURBINA

61706 KTBO - KIT BORRACHAS MOTOR

61706 KTAR - KIT ARRUELAS MOTOR

48373 CV
JTA TURBINA

61539 CB
JTA

XXXXX-KP
KIT PARAFUSOS DO CABEÇOTE

61706 KTRT
KIT DE RETENORES DO MOTOR
RET VALVULAS RET DIANT. VIRABREQUIN

02511 BRAG-F

02115 BRG S

02116 BA-P

8.3 12V .6C FORD - FORD CARGO: 1622 / 1722 / 2322 / 2425 / 3530 / 4030

8.3 12V 6C VW - CONSTELLATION: 16220 / 18310 / 24220 / 17300 / 17310

MTR: CUMMINS 6C / 6CT / 6CTA

60606-JGCB JG JTA MTR S/ CAB

60606-JGSC JG JTA MTR C/ CAB DE FIBRA

60606-JRSC JG JTA MTR C/ CAB DE FIBRA E C/ RET

60606-JGRS JG RETIF MTR S/ CAB

60606-JGRV JG RETIF MTR C/ CAB DE FIBRA

60606-JRRV JG RETIF MTR C/ CAB DE FIBRA E RET



61601 SC - JUNTA CABEÇOTE



60927 NA
JUNTA COLETOR ADMISSÃO



60825 NA
JUNTA COLETOR ADMISSÃO



60823 CV - TRAVA ESCAPAMENTO



60826 SI
JUNTA TAMPA
VALVULAS



60839 NA
JUNTA ADMISSÃO



60842 NA
JUNTA
TERMOSTATO



60843 NA
JUNTA CONEXÃO



60940 PAK
JUNTA ESCAPE



60916 NA
JUNTA CARTER



60872 F
JUNTA BASE



60873 CV
JUNTA SAÍDA



80876 NA
JUNTA ÓLEO

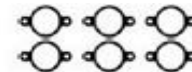

80921 F



49477 CV
JUNTA MESA

60897 CV - KIT JUNTAS TURBINA



60927 OR
JUNTA DISTRIBUIÇÃO



60928 NA
JUNTA INTERNA DISTR.



60676 NA
JUNTA FILTRO O'LEO



60678 NA
JUNTA FILTRO ÓLEO



60680 NA
JUNTA FILTRO ÓLEO



60848 NA
JUNTA CX DISTRIB.



60835 NA
JUNTA BOMBA
INJETORA



60841 NA-TEL
JUNTA BOMBA
ÓLEO



60844 NA
JUNTA TAMPA BOMBA
TRANSFERENCIA



60923 NA
JUNTA
ADMISSÃO



161824
ARRUELA



162227
ARRUELA



162430
ARRUELA



60041
BORRIFADOR SAÍDA
PISTÃO 4,5 CM

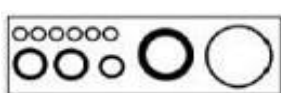

60606 KTBO SUP
KIT BORRACHAS MOTOR SUPERIOR

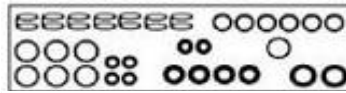

60606 KTAR INF
KIT ARRUELAS MOTOR INFERIOR



60606 KTBO INF
KIT BORRACHAS MOTOR INFERIOR



60833 NA
JUNTA FILTRO
ÓLEO



60834 NA
JUNTA
COMPRESSOR

XXXXX-KP
KIT PARAFUSOS DO CABEÇOTE

60606-KTRT
KIT DE RETENORES DO MOTOR
RET HASTE VALVULAS



73199 B

RET TRAS. VIRABREQUIM



RB 07648 T

RET DIANT. VIRABREQUIM



RB 07649 T

8.3 24V 6C FORD-CARGO E: C2932/6332/5032/4532:06/11-CARGO C:1933/AUTOMATIZ C193/3133 AÉ 4432: 06/19

8.3 24V 6C VW - 18320 OT/18330/26330/OTA AUT: 06/21-CONTELLATION:AUTOMATIZ/TITAN/V-TRONIC: 05/21

MTR: INTERACT-ISC 8.3 DSL TURBO INJEÇÃO DIRETA / ISL 8.9-ISL 320/330/360/400/420 DSL TURBO INJEÇÃO DIRETA/

60108-JGCB	JG JTA MTR S/ CAB	60108-JGRS	JG RETIF MTR S/ CAB
60108-JGSC	JG JTA MTR C/ CAB DE FIBRA	60108-JGRV	JG RETIF MTR C/ CAB DE FIBRA
60108-JRSC	JG JTA MTR C/ CAB DE FIBRA E C/ RET	60108-JRRV	JG RETIF MTR C/ CAB DE FIBRA E RET



60101 SC - 1,8 MM - CIL. 123,5 MM
JUNTA CABEÇOTE



60126 BO
JUNTA TAMPA VALVULAS



47223 F (1PÇ)
JUNTA COLETOR ESCAPE

Medidas	Qt.
2152	1
2142	1
2225	1
2123	1
7634	6
7740	1
7177	1
7334	2
7426	1
2111	B
2110	2
3012	2



Medidas	Qt.	MT
18x24x1,4	1	CU
14x22x1,5	1	AL
12x19x1,5	1	AL
7,5x15x1,5	4	CU

60108 KTAR SUP
KIT DE ARRUELAS DO MOTOR SUPERIOR



60127 BO
JUNTA DA TAMPA DE VALVULAS - BALANCEIROS



60119 PV
JUNTA DO COLETOR DE ADMISSÃO PQNA

47406 KTBO SUP
KIT DE BORRACHAS DO MOTOR SUPERIOR



60842 NA
JUNTA TERMOSTATO INFERIOR



60120 PV - JUNTA COLETOR ADMISSÃO GRANDE

JG JTA RETIFICAÇÃO



60848 NA
JUNTA TAMPA TRASEIRA



60873 CV
JUNTA TUBO COMPRESSOR



60136 NA
JUNTA



60135 NA
JUNTA



60139 NA
JUNTA CONEXÃO DE AR



60134 NA
JUNTA



60138 NA
JUNTA DO FILTRO DE ÓLEO



60133 NA
JUNTA

Medidas	Qt.	MT
18x24x1,5	1	CU
14x22x1,5	1	AL
12x19x1,5	13	AL

60108 KTAR INF
- KIT DE ARRUELAS DO MOTOR INFERIOR

Medidas	Qt.
2245	1
2241	1
2225	1
2119	1
2212	1
2019	1
7334	2
7668	1

60108 KTBO INF
- KIT DE BORRACHAS DO MOTOR INFERIOR

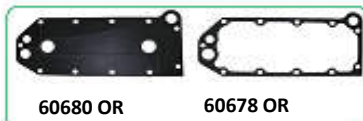

60681 KTOR
KIT JUNTAS DO RESFRIADOR DE ÓLEO



60140 KTNA
KIT DE JUNTAS DA ALIMENTAÇÃO



60028 OR
JUNTA CARÇA ENGENHAGEM



60916 NA
JUNTA CARTER

60108-KP
KIT PARAFUSOS DO CABEÇOTE
14.00X2.00X160.00 (X26)

60108-KTRT
KIT DE RETENORES DO MOTOR

RET HASTE VALVULAS

(7,97X14X18,6)



129001011

(75x93x8)



119011007

(130x150x12/13)





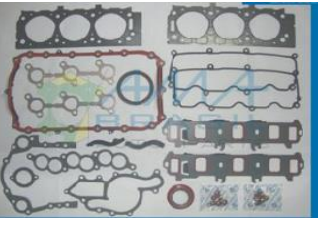
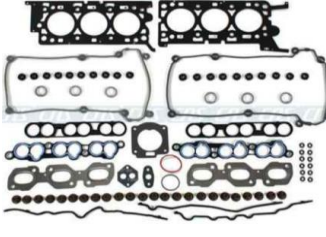
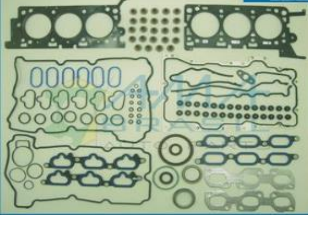

119021004

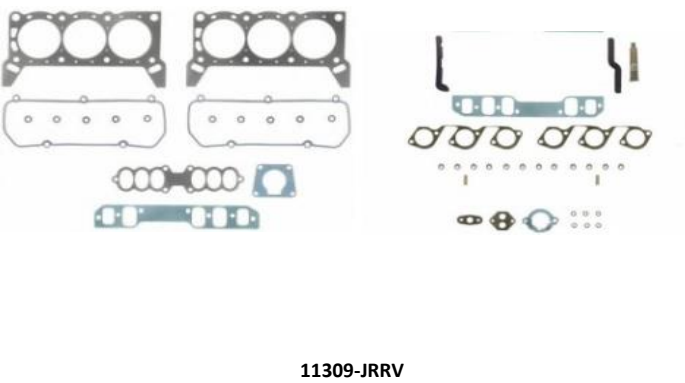
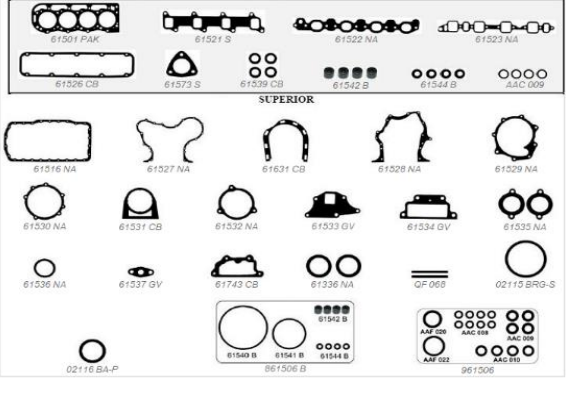
JUNTAS DIVERSAS DE MOTOR



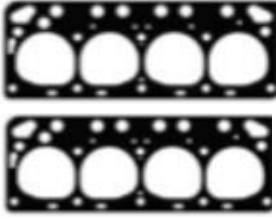







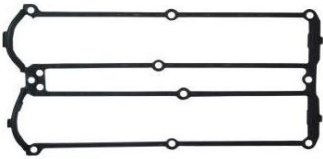
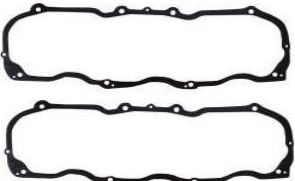
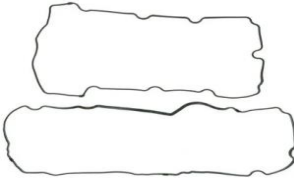

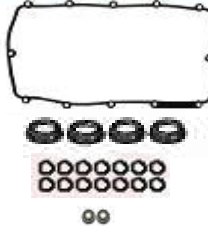
			
<p>11406 JGSC</p> <p>JOGO DE JUNTA DO MOTOR FORDINHO 29 - FORD A - 28/31</p>	<p>12106-JRSC</p> <p>JOGG DE JUNTAS DO MOTOR RANGER 3.0 12V V6</p>	<p>12109 JRML</p> <p>JOGO DE JUNTAS DO MOTOR DO TAURUS 3.0 24V V6</p>	<p>12110-JRML</p> <p>JOGO DE JUNTA DO MOTOR FUSION/TAURUS 3.0 V6 24V 2010 C/RET</p>

	
<p>11309-JRRV</p> <p>JOGO DE JUNTA DO MOTOR DO MUSTANG 3.8 V8 94/95 MTR 232 RWD</p>	<p>61506-JGSC</p> <p>JG JTA MTR TRATOR FORD 5600/10/6600/6610 4C</p>





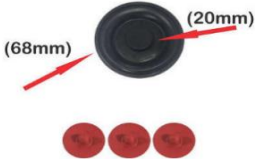

JUNTAS DIVERSAS DE CABEÇOTE

 <p>11402 SC</p>	 <p>11020 CV</p>	 <p>12102-SC</p>	 <p>12004 SC</p>
<p>JUNTA DO CABEÇOTE FORD 29 28/31 - MODELO A</p>	<p>JUNTA DO CABEÇOTE F100/F350/F600 GALAXIE V8 1955/1976 - MOTOR 272/292 NACIONAL PAR - CHAPA</p>	<p>JUNTA DO CABEÇOTE EDGE 3.5 V6 24V 08/16 DURATEC 1,20 MM - PAR</p>	<p>JUNTA DO CABEÇOTE FORD 3.0 12V V6 - USA</p>
 <p>12204 SC</p>	 <p>12303/4 MLS</p>		
<p>JUNTA DO CABEÇOTE FOCUS 2.0 16V DURATEC DIRECT FLEX 2014/</p>	<p>JUNTA DO CABEÇOTE MONDEO/FUSION: 3.0 24V V6 01/07 MTR REBA MEBA</p>		

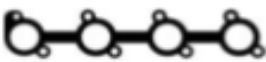

JUNTAS DE TAMPA DE VÁLVULAS

 <p>11524 BO</p>	 <p>11926 JGPAK</p>	 <p>12127 KTBO</p>	 <p>12427 KTBO</p>
<p>JUNTA DA TAMPA DE VÁLVULAS MONDEO 1.8/2.0 16V 98/00 -ZETE-S USA BORRACHA MOLDADA</p>	<p>JUNTA DA TAMPA DE VÁLVULAS RANGER 4.0 V6 C/ LIM (PAR) - ASBESTUS</p>	<p>JUNTA DA TAMPA DE VÁLVULAS FUSION 3.0 24 V V6 - REBA/MEBA - KIT=2 JTAS TV</p>	<p>JUNTA DA TAMPA DE VÁLVULAS EDGE 3.5 V6 24V 08/16 - KIT 2 PÇS</p>
 <p>12528-KTBO</p>	 <p>12725-KTBO</p>	 <p>12725-KTBO-DI</p>	 <p>12727-KTBO-DI</p>
<p>JUNTA DA TAMPA DE VÁLVULAS ECOSPORT 17/- KA KA+ 18/- FOCUS 19/: MTR DRAGON 1.5 12V 3CIL FLEX - KIT</p>	<p>JUNTA DA TAMPA DE VÁLVULAS RANGER/TRANS 22 16V 11/12 - C/ FUIROS - 19 PÇS</p>	<p>JUNTA DA TAMPA DE VÁLVULAS RANGER/TRANS 22 16V 4 CIL. 11/12 - C/ DIAFRAGMA E FUIROS</p>	<p>JTA TV RANGER 13/-T4:3.2 20V 5 CIL. DURATORQ TDCI SAFA DIESEL-C/DIAFRAGMA</p>
 <p>70154-KTBO-DI</p>	 <p>70155-KTBO-DI</p>	 <p>12249-DI</p>	 <p>12250-DI</p>
<p>JTA TV COM DIAFRAGMA TROLLER MTR NGD MWM POWER STROKE 3.0L 16V DIESEL RANGER FULL BR INTERCOOLER 08/10/2007 EM DIANTE</p>	<p>JTA TV COM DIAFRAGMA TROLLER MTR NGD MWM POWER STROKE 3.0L 16V DIESEL RANGER FULL BR INTERCOOLER 2005 A 09/2007</p>	<p>DIAFRAGMA DA TV FUSION ECOBOOST/EVO/FREELANDER-VOLVO: 2.0 16V</p>	<p>DIAFRAGMA MEMBRANA DO SUSPIRO DA TV ECOSPORT/FOCUS /FUSION/RANGER: 2.0/2.3 16</p>
 <p>12749-DI</p>	 <p>12749-KTDI</p>	 <p>70150 DI</p>	
<p>DIAFRAGMA DA TV RANGER/TRANSIT 2.2/4 16V- DIAFRAGMA TV</p>	<p>DIAFRAGMA DA TV RANGER/TRANSIT 2.2/2.4 16V KIT 4 PÇS</p>	<p>DIAFRAGMA DA TV RANGER 3.0 16V 05/12-TROLLER 08/12: POWER STROKE</p>	







JUNTAS DE COLETOR DE ESCAPE

 11119 MLS	 11119 SC	 11122 F	 11123 F
JTA COL ESC FIESTA 1.0 8V - SUPERCHARGER	JTA COL ESC FIESTA 1.0 8V - SUPERCHARGER	JTA COL ESC FORD ZETEC ROCAN /KA/FIESTA/ESC 1.0 8V	JTA COL ZETEC ROCAM 1.6 FIESTA/KA-SUPERCHARGER
 11722 PAK	 12223 F	 13322 PAK	
JTA COL ESC MAVERICK V8 (LEVA 2 PÇS)	JTA COL FUSION/EVOQUE /FREELANDER/V60/70/S60/80-11/14-204PT 2.5 16V	JTA TUBAGEM ADMISSÃO ESCAPE - ITAMARATY	





JUNTAS DE COLETOR DE ADMISSÃO

 11186 BQ	 12519 KTBO	 12520 KTBO 01	
BAQUELITE ADMISSÃO MONDEO 1.8/2.0 16V	JTA ADM KA/NEW FIESTA 1.0 12V 15/ECOBOOST C/CORPO DE BORBOLETA - 4PÇS	JTA ADM SIGMA/NEW FIESTA/FOCUS/KA 1.5/1.6 16V 5PÇS - C/ CORPO BORBOLETA	

JUNTAS DE ESCAPE

 11023 PAK	 11425 F	 11425 F A	 11820 FA
JTA ESCAPE ZETEC 1.8 / 2.0 16V - MONDEO 2.0 97 ED	JTA ESC ZETEC ROCAM: 1.0/1.6 8V	JTA ESC ZETEC ROCAM: 1.0/1.6 8V	JTA ESC VERONA/APOLLO/XR3 1.8/GOLF1.8/2.0 MI AUDI1.820V
 11820 PAK	 13027 PAK		
JTA ESC VERONA/APOLLO/XR3 1.8/GOLF1.8/2.0 MI AUDI1.820V	JTA ESCAPE WILLYS 6 CILS./ VW PUMA AR / VW: 1300/1500/1600 BEZORRÃO		









JUNTAS DO CATALIZADOR

 11837 PAK	 12537 F	 12568 F	 46622 F
JTA CATALIZADOR ESCORT XR3/LOGUS/VERONA	JTA CAT FOCUS/N FIES/FUS-SIGMA 1.6 16V/KA+1.5 16V	JTA CATALIZADOR ECOSPORT 17/-KA/NEW FIESTA/FOCUS 18/: 1.5 12V 18/ - 3C	JUNTA DO CATALIZADOR: GOL/ ESCORT/ LOGUS







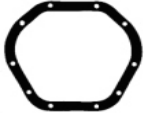

GAXETA DE ESCAPE

 11034 PAK	 11035 PAK	 11036 PAK	 11063 PAK
GAX ESC ESCORT CHT /86-VERONA 89/91 S/CATALIZADOR	GAX ESC ZETEC 1.8/2.0 16V-MONDEO IMPORTADO (TDS)	GAX ESC FOCUS FLEX: 1.6 8V-1.8/2.0 16V 45 X 61 ,5 X 19MM	GAX ESC ESCORT/FIESTA/KA/N FIESTA/FOCUS/1.0/ 1.6-ROCAN
 11134 PAK	 11136 PAK	 11963 PAK	 46035 PAK
GAX ESC ESCORT/FIESTA/KA MTR IMP - 75X92X14	GAX ESC FIESTA/KA 1.0/3 END ANEL -96X104X5	GAX ESC RANGER 4 / 6 CILINDROS E9TZ/5E241/A	GOL AE /BX / ESCORT /PARATI / SAVEIRO:TODOS-305253.12371
 46939 PAK	 71163 PAK	 71263 PAK	
GAX ESC VERSAILLES/ROYALLE 1.8/2.0 (TODOS) 855253137	GAX ESC 229/F1000/2/4 - 57,5X71X111	GAX ESC 226/F4000 75/... - 63X76X11	



BAQUELITES: CARBURADOR E BOMBA COMBÚSTIVEL







 10968 BQ	 11062 BQ	 11272 BQ	 11344 BQ
BAQUELITE CARB. CHEVETTE DUPLO MINI PROGRESSIVO	BAQUELITE INJEÇÃO ELET. FORD FIESTA ENDURA	BAQUELITE BOMBA GASOLINA CORCEL	BAQUELITE CARBURADOR SOLEX DUPLO CORCEL II
 11345 BQ	 11658 BQ	 11867 BQ	 11868 BQ
BAQUELITE CARBURADOR MAV 4C/CORCEL II WEBER DUP	BAQUELITE SOLEX SIMPLES CORCEL/DEL REY ALC .79/82	BAQUELITE DISTANCIADOR CARBURADOR DO CHT	BAQUELITE CARBURADOR WEBER CHT
 11869 BQ			
BAQUELITE INFERIOR CARBURADOR WEBER CHT			







DIVERSAS JUNTAS DE CUBO E DIFERENCIAL

 10518 NA	 13346 GV	 11642 GV	 11654 NA
JTA DIF WILLYS 6C-37671 F1000/GALAXIE-B7A4035-DANA	JTA RODA LIVRE WILLYS: JEEP / RURAL / F75 - B16691	JTA SEMI-EIXO F350 / F4000 - B6Y1144A	JTA DIFERENCIAL PAMPA 4 X 4
 11842 NA	 11931 NA	 13348 GV	 13362 GV
JUNTA DO CUBO F 12000 SAPAO/VW/GM: 77/ TRASEIRO	JTA DIFERENCIAL F350 (55/67) B5Y4035A	JTA SEMI-EIXO F2000 / AGRALE	JTA SEMI-EIXO F75 / JEEP / F100 / GALAXIE-B18691







JOGOS DE JUNTAS DA TURBINA

							
11463 F		50545 S		91423 AI			
11486 CV Jogo de juntas para turbina - Ranger 2.2 / 3.2							
N/Número	Original	Descrição	QT	N/Número	Original	Descrição	QT
11463 F		Junta do caracol	01	91423 AI		Junta	01
50545 S		Junta do cano de óleo	01				





															
11573 FF		11576 NA		11577 FF		46575 NA		50545 S		AAA 008/A		AAA 012/A			
11586 CV Jogo de juntas para turbina - Transit 2.2 / 3.2 L															
N/Número	Original	Descrição	QT	N/Número	Original	Descrição	QT	N/Número	Original	Descrição	QT	N/Número	Original	Descrição	QT
11573 FF	801748	Junta da saída do turbo	01	50545 S	99436992	Junta do cano de óleo	01								
11576 NA	801747	Junta da entrada de óleo	01	AAA 008/A		Arr. alumínio 8 x 14 x 1,0 mm	01								
11577 FF	801749	Junta da base	01	AAA 012/A		Arr. alumínio 12 x 16 x 1,5 mm	02								
46575 NA	058145757B	Junta do cano de retorno	01												

											
12372 FF		12373 FF		46575 NA		50545 S		AAA 008/A		AAA 012/A	
11686 CV Jogo de juntas para turbina - Ranger Rover TDV6-3											
N/Número	Original	Descrição	QT	N/Número	Original	Descrição	QT	N/Número	Original	Descrição	QT
12372 FF		Junta	01	50545 S	99436992	Junta do cano de óleo	01				
12373 FF		Junta	01	AAA 008/A		Arr. alumínio 8 x 14 x 1,0 mm	01				
46575 NA	058145757B	Junta do cano de retorno	01	AAA 012/A		Arr. alumínio 12 x 16 x 1,5 mm	02				





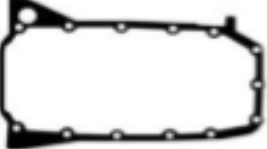
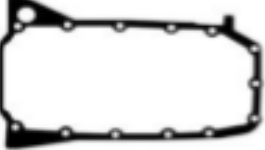
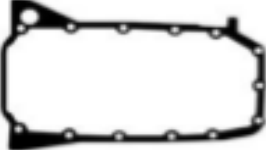
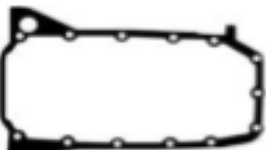

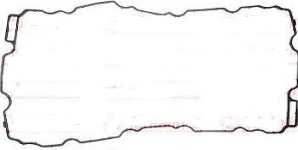



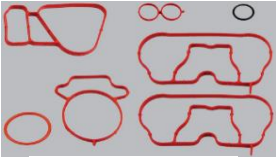











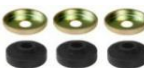

					
70280 CV JG JTA TURB RANGER 2.8 8V 02/					

															
48383 CV		59266 NA		59376 NA		71373 CV		AAA 010/A		AAA 014		SCNA 308806			
71195/3 CV Jogo de juntas para turbina -S2A F-1000 APL															
N/Número	Original	Descrição	QT	N/Número	Original	Descrição	QT	N/Número	Original	Descrição	QT	N/Número	Original	Descrição	QT
48383 CV		Junta da base	01	AAA 010/A		Arr. alumínio	04								
59266 NA	1671153	Junta da lubrificação	01	AAA 014		Arr. alumínio 14x20x1,5mm	02								
59376 NA	1671152	Junta do cano de retorno	01	SCNA 308806		Junta de papelão hidráulico	01								
71373 CV		Junta	01												

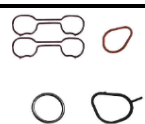









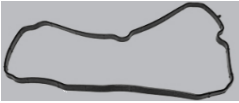

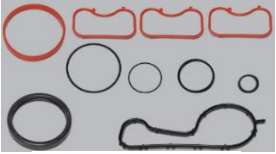
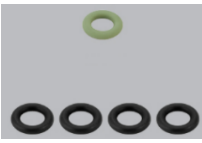
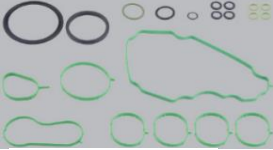

DIVERSAS DE CARTER

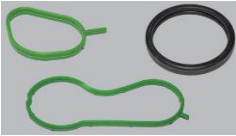
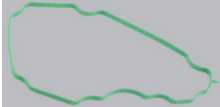
 <p>11016BI</p>	 <p>11216 BI</p>	 <p>11216 CBBI</p>	 <p>11516 BA</p>
<p>JTA CRT ZETEC ROCAM 1.0/1.6 FIESTA/KA - ALUMINIO / BORRACHA - TIPO ORIGINAL</p>	<p>JTA CRT FIESTA/KA 1.0/3 ALUMINIO</p>	<p>JTA CRT FIESTA/KA 1.0/13: 8V ENDURA - MOLDADO</p>	<p>JTA CRT ZETEC 1.4 16V/SIGMA: 1.5/1.6 16V - BORRACHA MOLDADA</p>
 <p>11516 CBLT</p>	 <p>11516 NA</p>	 <p>11516 PAK</p>	
<p>JTA CRT ZETEC 1.4 16V/SIGMA: 1.5/1.6 16V - COM LIMITADORES</p>	<p>JTA CRT ZETEC 1.4 16V/SIGMA: 1.5/1.6 16V - NÃO AMIANTO</p>	<p>JTA CRT ZETEC 1.4 16V/SIGMA: 1.5/1.6 16V - ASBESTUS</p>	
 <p>12716 KTNM</p>		 <p>60017 BO</p>	
<p>JTA CRT RANGER/TRANSIT 2.2/4 16V-C/SOBRE CRT-3 PÇS</p>		<p>JTA CARTER CUMMINS 2.8 16V: F350 /F4000: 14/19*4-150/6-160: ISF 2.8 DSL TURBO ID "2 RETANGULOS"</p>	



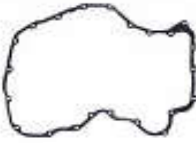

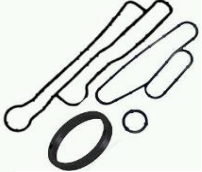





DIVERSAS

			
11004-KTBO	11047-BO	11049-BO	11087 BO
JOGO DE BORRACHAS DO MOTOR ROCAN: 1.0/1.6 8V	BUCHA DA ELETRO BOMBA PARTIDA FIESTA/ECOSPORT/NEW FIESTA/FOCUS/KA	BUCHA ANTI-CHAMA ZETEC ROCAM 1.0/1.6 8V	ANEL VÁLV.TERMOSTÁTICA ZETEC ROCAM/ FIESTA 03/
			
11095-BO	11096-BO	11135 BO	11138 BO
JUNTA CARÇAÇA TERMOSTATO ZETEC 1.8/2.0 16V	JUNTA TERMOSTATO ZETEC 1.8/2.0 16V	JTA GUARNIÇÃO FLANGE BBA. GOL/PARATI/LOGUS/POINTER/SA VEIRO/ESCORT/VERONA	JTA VEDADOR BOCA TAMQUE CORCEL II
			
11149 BO	11223-BO	11232 CI	11232 FA
JTA GUARNIÇÃO BOMBA COMBUSTÍVEL COURRIER	BORRACHA CRT PEQ C/MARCA CORCEL II	ARRUELA CRT CORCEL I	ARRUELA CRT CORCEL I
			
11267 CB	11452 BO	11635 BC	11646 BO
JTA BÓIA TAMQUE F2000/ F4000/ WILLYS/ CORCEL	ANEL OITO MOTOR ENDURA 1.0/1.3 8V	JG BORRACHAS TAMPA VÁLV. CORCEL I / II / CHT	VEDADOR DO RESERV DE AGUA CORCEL I / II - BELINA - DEL REY
			
11647 FI	11718 BO	11732 CB	11803-KTBO
ARRUELA DO BUJÃO DO CARTER CORCELII - 14X24X1,5 MM - FIBRA	MEIA LUA DO CARTER DO MAVERICK / GALAXIE : V8 - MOTOR 302 74/81 - 1 PÇ	VEDADOR DA TAMPA DA BOMBA DE ÓLEO-MAVERICK / GALAXIE - 302 V8	KIT BORRACHAS MOTOR ZETEC 1.4 16V COURIER - 3 PÇS
			
11816 JGBO	11942 BO	11952 A	11953 A
JOGO DE MEIA LUA DO CARTER CHT - PAR	JTA PINÇA DE FREIO FORD PICK UP - BORRACHA	JTA DIV GAX MANCAL FORD TRAS 8 CILINDROS TDS	JTA DIV GAX TRATOR FORD SELO DE OLEO TDS - LATERAL
			
12207-KTBO-1-SUP			
KIT BORRACHAS MOTOR SUPERIOR DURATEC 2.0 16V - C/ADMISSÃO - 7PÇS			

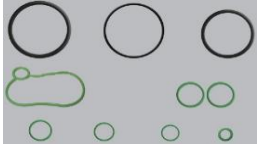
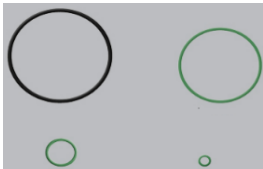
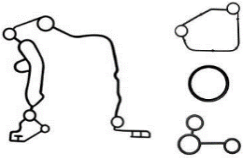
DIVERSAS

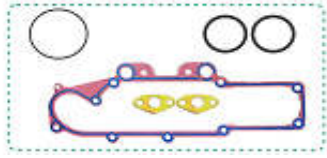
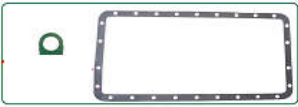
 <p>12230-BO</p>	 <p>12231-BO</p>	 <p>12232-BO</p>	 <p>12244-BO</p>
<p>JUNTA SEPARADOR VAPOR OLEO DURATEC 2.0/1.3 16V -</p>	<p>ANEL BBA DAGUA DURATEC 2.0/1.3 16V</p>	<p>JUNTA TERMOSTATO DURATEC 2.0/1.3 16V ECOBOOST</p>	<p>JUNTA BOMBA COMBUSTIVELDURATEC 2.0/1.3 16V -</p>
 <p>12247-BO</p>	 <p>12505-KTBO-01</p>	 <p>12506 JGABI</p>	 <p>12506-KTBO-01</p>
<p>ANEL BUJAO CRT - FORD BOR RACHA SINTÉTICA 3MM 14 X 22 MM</p>	<p>KIT BORRACHAS MOTOR KA/NEW FIESTA 1.0 12V 3C ECOBOOST C/ADM - 10PÇ</p>	<p>ANEL BICO INJETOR SIGMA 1.5/1.6 16V NEW FIESTA/FOCUS/KA-</p>	<p>KIT BORRACHAS MOTOR SIGMA 1.5/1.6 16V NEW FIESTA/FOCUS/KA - 21 PÇS</p>
 <p>12533-KTBO</p>	 <p>12533-1-KTBO</p>	 <p>12534-BO</p>	 <p>12535-KTBO</p>
<p>KIT BORRACHAS TERMOSTATO SIGMA 1.5/1.6 16V NEW FIESTA/FOCUS/KA - 2PÇS</p>	<p>KIT BORRACHAS MOTOR SIGMA 1.5/1.6 16V NEW FIESTA/FOCUS/KA - 3PÇS</p>	<p>JUNTA SEPARADOR CRT SIGMA 1.6 16V NEW FIESTA/FOCUS/KA 1.5 16V</p>	<p>KIT BORRACHAS BOMB A D'AGUA SIGMA 1.5/1.6 16V NEW FIESTA/FOCUS/KA - 3 PÇS</p>
 <p>12538-BO</p>	 <p>12582 BO</p>	 <p>12728 NA</p>	 <p>12728 KTNA</p>
<p>JUNTA TERMOSTATO SIGMA 1.5/1.6 16V NEW FIESTA/FOCUS/KA/COURIER 1.4 16V</p>	<p>JTA TERMOSTATO KA/KA+ NEW FIESTA 1.0 12V 15/ 3C ECOBOSST</p>	<p>JTA TD TRANSIT 2.2/4 16V- RANGER/DEFENDER: 13/-SOBRE CRT</p>	<p>KIT JTA TD TRANSIT 2.2/4 16V-RANGER/ DEFENDER: 13/-SOBRE CRT - 2 PÇS</p>
 <p>12729 NA</p>	 <p>12743-KTBO</p>	 <p>13338 BO</p>	 <p>13388 BO</p>
<p>JTA TD TRANSIT 2.2/4 16V- RANGER/DEFENDER 13/-SOBRE CRT</p>	<p>KIT JUNTAS TROCADOR CALOR RANGER/TRANSIT 2.2/4 16V</p>	<p>JTA BOMBA GASOLINA WILLYS / JEEP</p>	<p>VEDACAO DO FILTRO OLEO WILLYS 4/6 CILS</p>

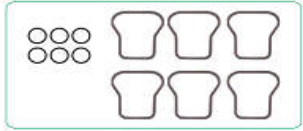
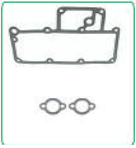
DIVERSAS

 <p>62027 BO  62045 JGBO</p> <p>60027 KTBO</p>	 <p>60053 OR</p>	 <p>62044 BO</p>	 <p>62306 KTBO</p>
<p>KIT DE JUNTAS DA TAMPA DE VÁLVULAS DO CUMMINS ISF 3.8 16V TURBO INJEÇÃO DIRETA</p>	<p>JUNTA DO FILTRO DE ÓLEO: CUMMINS 6B/6BT/6BTA: 5.9 16V</p>	<p>JUNTA BOMBA DE ÓLEO: VW 12240 A 31260 MAN TGL 4.6 16V/6.9 24V</p>	<p>KIT DE BORRACHAS DO MOTOR: MAN D0834/D0836</p>
 <p>62344 KTBO</p>	 <p>70124 KTBO</p>	 <p>71023 MLS</p>	 <p>71035 KTNB</p>
<p>KIT DE BORRACHAS DO FILTRO DE ÓLEO MAN D0834/D0836</p>	<p>KIT DE JUNTAS DA DISTRIBUIÇÃO DE ÓLEO RANGER 3.0 16V DISTRIB 05/</p>	<p>JTA ESC SPRINT MWM 4/6 CIL OVAL - 1 PÇS / LEVA 2 PÇS</p>	<p>KIT JUNTAS REFRIGERAÇÃO DO ÓLEO SPRINT MWM 4/6 CIL</p>
 <p>71096 KTNA</p>	 <p>71122 NA</p>	 <p>71147 NA</p>	 <p>71826 KTBO</p>
<p>KIT JTA CRT SPRINT 4 CIL-S10/FROTIER: 2.8 8V</p>	<p>JUNTA DA ADMISSÃO SPRINT 4 CIL 4,07 PH NÃO AMIANTO</p>	<p>ARRUELA DO BUJÃO DE CARTER: SPRINT MWM 4 CIL</p>	<p>KIT DE JUNTA DA TAMPA DE VÁLVULAS: X10 4.10/6.10/X12 - 4/6 CIL - 12 PÇS</p>
 <p>71534 KTNA</p>	 <p>OR1-229</p>	 <p>OR1-1244-PRETO</p>	
<p>KIT DE JUNTAS DO RADIADOR DE ÓLEO X-10/X12: 4/6 CIL</p>	<p>ANEL BÓIA COMB:CORCEL/ DELREY/PAMPA 78 ED/ F-100/F-1000 COAF9276A</p>	<p>ANEL BICO INJETOR SIGMA 1.5/6 16V - TIPO B PRETO</p>	

CÂMBIOS



11140 PV Jogo para câmbio Clark CL 450- 5 marchas- caminhão VW 11.130 / 13.130 / Ford / GM / Dodge

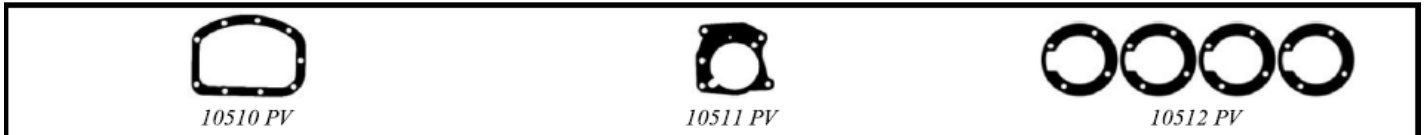

11184 PV Jogo para câmbio Clark 260T - F-100 3M (61/76) alavanca na direção nacional sincronizado- orig. B8AZ-7153-A

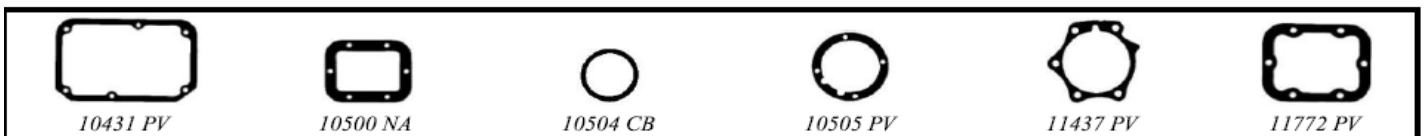

11188 PV Jogo para câmbio ex. 240 F/FS Ford F.1 / F.6 / F.100 / F.350 / F.600 4M (importado sincronizado) orig. B894-7153-A

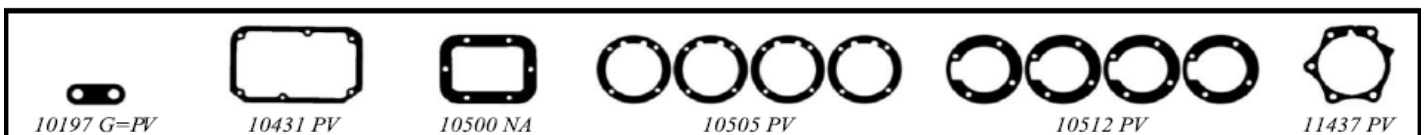

11189 PV Jogo para câmbio Clark α. 240 F/FS F-350 / F-600 (61/71) / 4 Marchas (nacional sincronizado) . ABT-7153-A

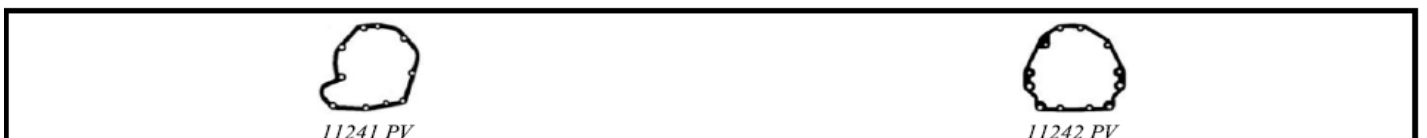

11191 PV N.Orig. BD2M-7153-A Jogo para câmbio- Corcel / Belina 4 marchas 1968 em diante

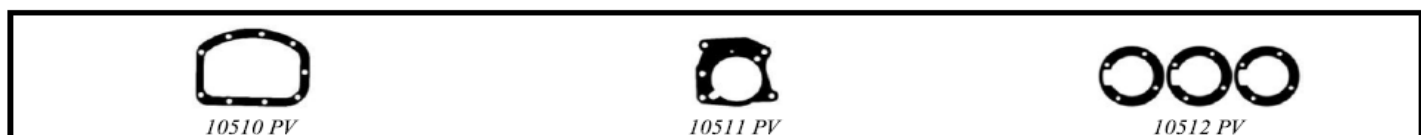

11192 PV N. Orig. BC7A-7153 Jogo para câmbio- Ford / Galaxie 1967 / 1976

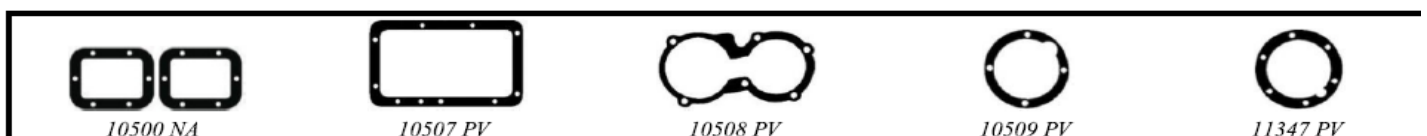

11193 PV N. Orig. BCST-7153-C Jogo para câmbio F600 Fuller seco 5 marchas

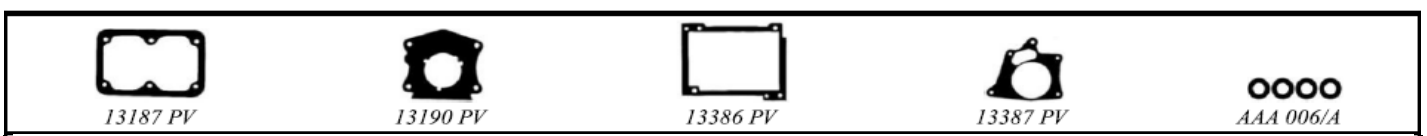



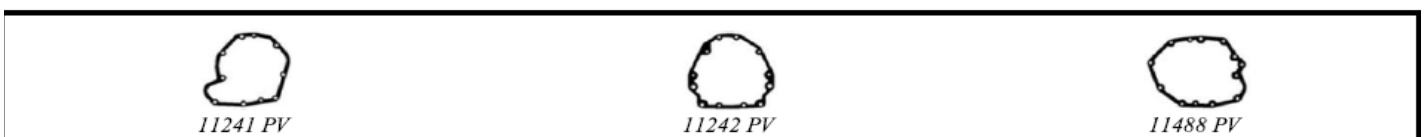











11380 GV Jogo para câmbio WILLYS: JEEP / RURAL / AERO WILLYS / ITAMARATY / PICK UP WILLYS -FORD: MAVERICK 4 C / F100 / F75







11481 PV N.Original BE2M-7153-B Jogo p/câmbio Corcel II 1.6 / Del Rey / Pampa / Scala 4/5 marchas 68 ED

CÂMBIOS

					
10510 PV	10511 PV	10512 PV	10548 PV	10549 PV	11781 PV
11780 PV Jogo para câmbio Clark 260T – Maverick 8cc / Galaxie 4 marchas 1967 em diante					





















							
11882 NA	11883 NA	11885 NA	11886 CB	11887 PP	AAA 016/A	ORING 6765	ORING
11879 NA Jogo para câmbio Ford Ka / Fiesta / Focus / Eco Sport / Courier 96 em diante Cx. I B 5							

		
11882 NA	11883 NA	11884 NA
11880 NA N. Orig. 84875/1 Jogo para câmbio Escort 4 marchas 1983 em diante		





			
11662 NA	11882 NA	11883 NA	11884 NA
11881 NA N.Orig. 84875 Jogo para câmbio Escort 5 marchas 1983 em diante			



								
13186 PV	13187 PV	13188 PV	13189 CB	13190 PV	13191 NA	13386 PV	13387 PV	AAA 006/A
13680 PV N.Orig. 805295 / 644122-B. Jogo p/câmbio - Aero Willys / Jeep / Rural / Pick up tração 4 rodas 6cc c/ reduzida								

CARBURADOR

															
															
11157 GV Jogo para carburador Holley- caminhão 8cc motor brasileiro- modelos F-100 / F-600- 58 / 66 – passeio 55 / 57															

					
11489 GV	11490 GV	11491 GV	11999 NA	AAF 011/B	ORI 008
11160 GV Jogo para carburador Weber- F-100 / 350 / 600 / Galaxie 500 LTD 8 CC. 67 ED					

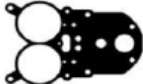
				
10535 GV	10536 NA	11247 NA	AAF 006 / A	AAF 010
11162 GV Jogo para carburador DFV simples- Corcel II 1.4 / 1.6 / Del Rey / Pampa / Belina 72 ED				

				
11167 GV	11342 GV	11393 NA	11395 NA	AAA 012
11350 GV Jogo para carburador Solex duplo- Corcel II 1.6 / Del Rey / Pampa				

CARBURADOR



11351 NA Jogo para carburador importado- Maverick 8 cc / Galaxie (anos todos)

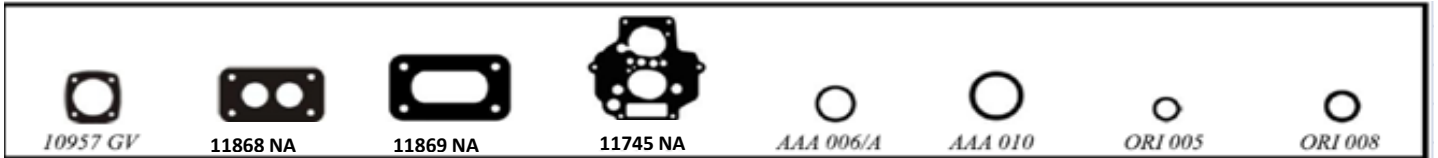

11850 GV Jogo para carburador DFV DUPLO - corcel / escort / del rey - CHT

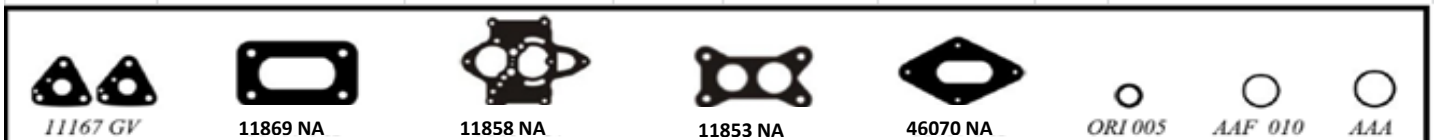

11851 GV Ig. p/carb. solex duplo BLFA - Monza 1.8/2.0 /Escort / Monza / Del Rey 1.8M / Gol / Santana 1.8/2.0 (alc./gás.)

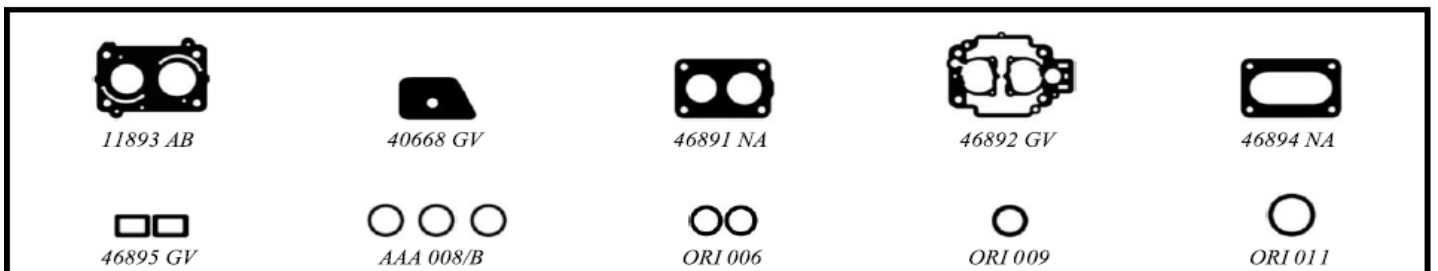

11870 GV Jogo para carburador Weber TLDR- Escort XR-3 / Del Rey / Pampa 1990 ED



13350 GV N.Orig. 75BU-9510-B Jogo para carburador- Jeep / Rural / Pick up / F-75 1958/1962 6 cc.

JOGOS E REPAROS - INJEÇÃO ELETRÔNICA



11042 NA Reparo para I.E- Ford Ranger 2.3 / 2.5 M.P







11042 SCKIT Reparo para I.E- Ford Ranger 2.3 / 2.5









11050 NA Jogo para I.E- Escort XR-3 / Royale / Versailles até 93 - Santana 2.0 - multipoint - sistema Bosch











JOGOS E REPAROS - INJEÇÃO ELETRÔNICA













						
11042 NA	11071 NA	11072 NA	11075 CB	11095	46341 B	ORI 203
SCKIT 11050 <i>Reparo para I.E– Escort XR-3 / Royale / Versailles até 93 – Santana 2.0– multipoint – sistema Bosch</i>						

			
11061 NA	11062 NS	ORI 112	ORI 123
11060 NA <i>Jogo para I.E– Fiesta 1.3 importado– sistema FIC EEC IV – c/ baquelite</i>			







				
11065 NA	11071 NA	11073 NA	11074 NA	ORI 203
11070 NA <i>Jogo para I.E– Fiesta CLX</i>				







					
11065 NA	11071 NA	11073 NA	11074 NA	11095	ORI 203
SCKIT 11070 <i>Reparo para I.E.– Fiesta CLX</i>					

					
11081 NA	11082 NA	40051 GV	46062 NA	46071 NA	
					
46072 NA	ORI 014	ORI 018	ORI 019	ORI 2116	SCBQ 1006
11080 NA <i>Jogo para I.E–Royale / Versailles – single Point– sistema Magnetti Marelli – s/ baquelite</i>					
11080 NA-BQ <i>Jogo para I.E–Royale / Versailles – single Point– sistema Magnetti Marelli – c/ baquelite</i>					

					
11066	11081 NA	11082 NA	11084	46062 NA	46071 NA
					
46072 NA	ORI 014	ORI 018	ORI 019	ORI 2116	SCBQ 1006
SCKIT 11080 <i>Reparo para I.E–Royale / Versailles – single oint – sistema Magnetti Marelli - c/ baquelite</i>					

					
11093 FE	11095	11096 B	11097 B	11098 B	11099 B
11088 B <i>Reparo para I.E– motor Zetec 1.8 16 V. – sistema FIC</i>					

					
11093 FE	11094 B	11095	11097 B	11098 B	11099 B
11089 B <i>Reparo para I.E– Fiesta / Courier 1.4 / 16 V. – sistema FIC</i>					

						
11235 BO	11092 B	11093 FE	11095	11098 B	11099 B	ORI 203
11090 B <i>Reparo para I.E– Courier / Fiesta / Ka / motor endura– sistema FIC</i>						

JOGOS E REPAROS - INJEÇÃO ELETRÔNICA



11043 NA



11049 NA



11071 NA



11098 B



11099 B

11150 NA Jogo para I.E- Focus / Mondeo – Zetec 2.0 16 válvulas



11043 NA



11049 NA



11071 NA



11095



11098 B



11099 B

SCKIT 11150 Reparo para I.E- Focus / Mondeo – Zetec 2.0 16 válvulas



11041 NA



11171 NA



11172 NA



11173 NA



ORI 203

11170 NA Jogo para I.E- Ford Ranger 4 cilindros importada



11071 NA



11165 NA



11166 NA



ORI 203

SCKIT 11170 Jogo para I.E- Ford Ranger 4.0 L- 6 cilindros 94 à 01/97



11170 KTBO JG JTA IE RANGER/EXPL 4.0 V6 94/97 BOSCH

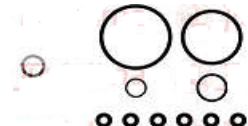

11170 KTBO 01 JG JTA IE RANGER/EXPL 4.0 V6 94/97



11041 NA



11042 NA



11071 NA



11186 NA



ORI 203

SCKIT 11180 Jogo para I.E.- Ranger 94/97 – motor Mazda DOHC 4cc 2300 L/Ranger 98 / mtr SOHC 4cc 2500 dupla



10432 NA



11071 NA



11187 NA



ORI 203

SCKIT 11190 Jogo para I.E- Ford Windstar 94- motor 3.8 L 6cc - EFI / MI



11042 NA



11071 NA



11169 NA



11098 B



ORI 203

SCKIT 11200 Jogo para I.E.- Ranger 94/95 ED- motor 6 cc (importada)



11173 NA



11281 NA



11282 NA



11283 NA



ORI 203

11280 NA Jogo para I.E - F-1000 95/98 4.9L



11156 B



11159 B



ORI 203



11095

11360 B Jogo para I.E.- EcoSport / Focus / Ranger



11092 B



11098 B



11121 JGSI



11335 SI



ORI 011



ORI 203

SCKIT 11640 Jogo para I.E.Zetec Rocam 1.0 I/ Ka 08/99 ed / Fiesta 96 ed/ Fiesta sedan 09/99 ed/ 1.0 I. aspirado 10/01 / Fiesta 03 ed 1.0 I. - aspirado 04/02 ed.

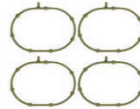

12560 KTBO

KIT INJ ELET TBI ZETEC-S (16HDEZ) SIGMA 1.6 16V FLEX (TiVCT) NEW FIESTA ECOSPORT 13/... FOCUS 07/...BOSCH





11170 KTBO





JG JTA IE RANGER 2.3 16V DURATEC GAS - TBI M POINT - KITBOSCH





DIVERSAS DE INJEÇÃO

			
11061 NA	11064 AL	11174 NA	11578 BO
JTA INJEÇÃO ELETRÔNICA FORD	JTA INJEÇÃO ELETRÔNICA GOL 1000 MI (ALUMÍNIO)	JTA INJEÇÃO - TBI F-250 (GÁS) F75Z9E936AA	VEDADOR CORPO BORBOLETA FOCUS 1.8/2.0 16V 00/05

			
11706-ABI	12506 JGABI		
KIT ANEL BICO INJETOR ZETEC 1.8/2.0 16V-A	KIT ANEL BICO INJETOR SIGMA 1.5/1.6 16V NEW FIESTA/FOCUS/KA-		









DIVERSAS DE CARBURAÇÃO

			
11336 NA	11363 NA	11364 NA	11631 CB
JTA ADMISSÃO ENTRE ADMISSÃO E CARBURADOR MAVERICK 4C	JTA BASE CARBURADOR MAVERICK - 8 CILINDROS	JTA BASE CARBURADOR MAVERICK - 8 CILINDROS	JTA ISOLADORA FILTRO AR NºORIG: BD9M9654A

			
11750 GV	11750 NA	11751 GV	11844 BO
JUNTA DA BASE DO CARBURADOR QUADRIJET 4 F VELOMOIDE 1,6 MM	JUNTA DA BASE DO CARBURADOR QUADRIJET 4 F NÃO AMIANTO 1,6 MM	JUNTA DA BASE DO CARBURADOR QUADRIJET 8 F EDELBROCK- GUARNITAL 1,6 MM	VEDADOR DO FILTRO DE AR DO MOTOR CHT

			
13393 NA			
JUNTA DA BASE DO CARBURADOR DFV WILLYS 6 C			

KIT CARBURADOR

 <p>10860-KS-01</p>	 <p>13350-KS</p>	 <p>11162-KS</p>	 <p>11162-KS-01</p>
<p>KIT CARB 2000- VERSAILLES/ ROYALE- 89 ALC. BROSOL - 3E</p>	<p>KIT CARB AERO WILLYS/ PERUA/ JEEP/ PICK-UP 6 C 58 A 75 WEBER - DFV 228</p>	<p>KIT CARB CORCEL 1.3 E 1.4 - 68 A 73 GASOLINA WEBER - DFV 228</p>	<p>KIT CARB CORCEL II/ BELINA II/ 1.4 E 1.6 1974 A 83 WEBER - DFV 228</p>
 <p>11350-KS</p>	 <p>11870-KS</p>	 <p>46050-KS-02</p>	 <p>10156-KS</p>
<p>KIT CARB CORCEL/ DEL REY- 78 A 82/ MAVERICK- 74 A 85 DUPLO BROSOL - 34 SEIE</p>	<p>KIT CARB ESCORT XR3/ VERONA1.8/ MOTOR TRANSVERSAL ELETRONICO WEBER 499 - TLDf</p>	<p>KIT CARB ESCORT/ PAMPA/ VERONA GLX/ VERSAILLES/ ROYALE ELETRONICO</p>	<p>KIT CARB JEEP/ PICK UP/ RURAL WILLYS/ F-75 4CIL/ F1000-85 BROSOL - 40 EIS - 185</p>